



PFI 1212E - 1218E

Koeltorens met gesloten circuit

Technische gegevens

Opmerking: Niet gebruiken voor constructie. Raadpleeg de door de fabriek gecertificeerde afmetingen en gewichten. Deze pagina bevat gegevens die actueel zijn op het moment van publicatie, die op het moment van aankoop opnieuw moeten worden bevestigd. In het belang van productverbetering kunnen specificaties, gewichten en afmetingen zonder voorafgaande kennisgeving worden gewijzigd.

[PFI koeltorenprestaties bij standaardomstandigheden - 30% EG](#)

[PFI koeltorenprestaties bij standaardomstandigheden - 30% PG](#)

[PFI koeltorenprestaties bij standaardomstandigheden - water](#)

[PFI koeltoren - drukval](#)

Laatst bijgewerkt: 22/01/2025

PFI 1212E - 1218E

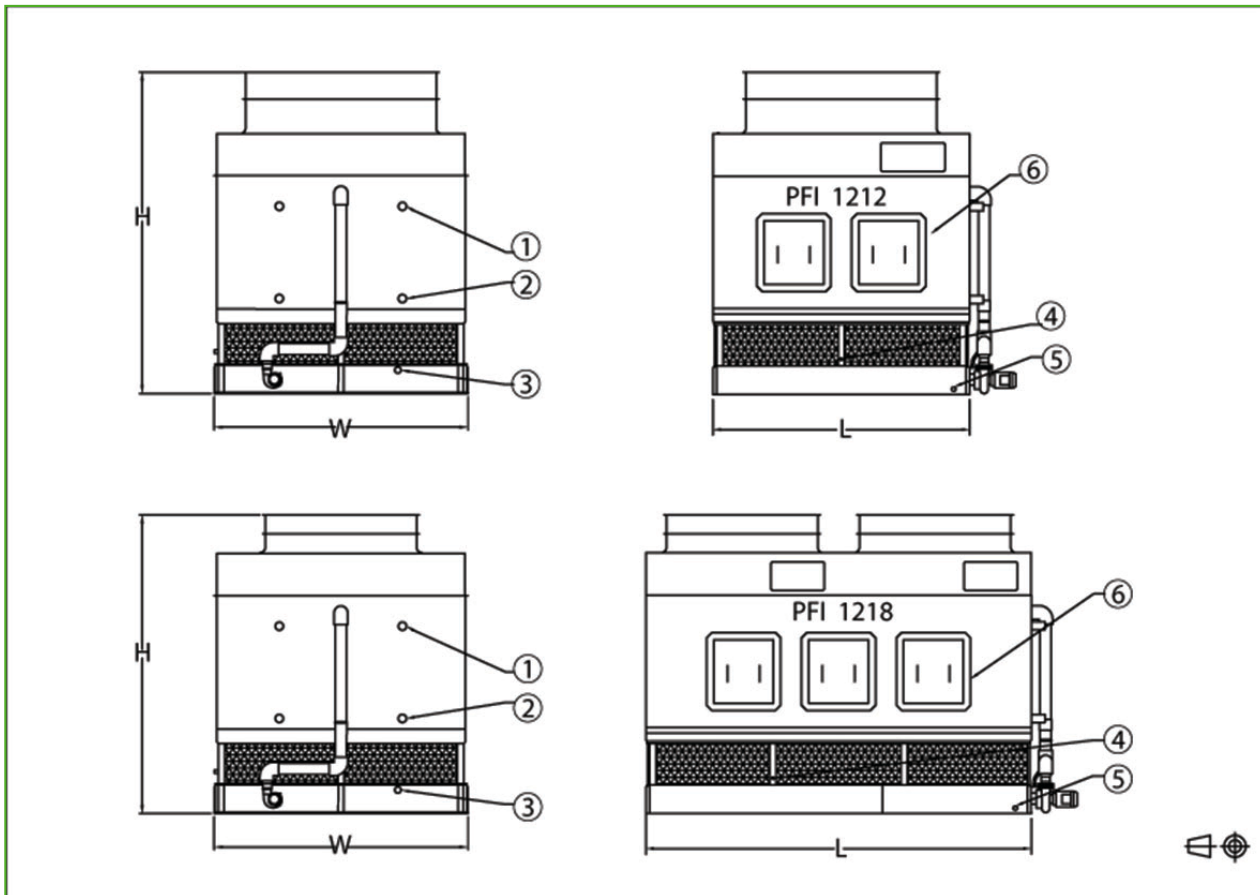

1. Vloeistof in; 2. Vloeistof uit; 3. Overloop; 4. Make-up; 5. Afvoer; 6. Batterij-inspectieluiken



Model	Gewicht (kg)			Afmetingen (mm)			Luchtdebi et (m ³ /s)	Ventilator motor (kW)	Sproeiwat erdebiet (l/s)	Pompmot or (kW)	Batterijnh oud (l)
	Bedrijfsge wicht (kg)	Transport gewicht (kg)	Zwaarste gedeelte (kg)	L	W	H					
PFI 12 12E-2D 3ES-L	9307	6297	4105	3651	3607	5535	35.2	(1x) 11.0	25.0	(1x) 4.0	(2x) 426
PFI 12 12E-2D 4DS-M	9307	6237	4019	3651	3607	5345	39.4	(1x) 15.0	25.0	(1x) 4.0	(2x) 456
PFI 12 12E-2D 4ES-O	9657	6565	4309	3651	3607	5535	43.2	(1x) 22.0	25.0	(1x) 4.0	(2x) 467
PFI 12 12E-3D 1DS-P	9688	6523	4196	3651	3607	5345	50.6	(1x) 30.0	25.0	(1x) 4.0	(2x) 504
PFI 12 12E-3D 2DS-P	10020	6759	4432	3651	3607	5345	48.7	(1x) 30.0	25.0	(1x) 4.0	(2x) 553
PFI 12 12E-3D 3DS-M	10247	6886	4667	3651	3607	5345	37.5	(1x) 15.0	25.0	(1x) 4.0	(2x) 602
PFI 12 12E-3D 3ES-N	10669	7292	5058	3651	3607	5726	38.9	(1x) 18.5	25.0	(1x) 4.0	(2x) 611
PFI 12 12E-3D 4DS-L	10619	7141	4949	3651	3607	5345	33.3	(1x) 11.0	25.0	(1x) 4.0	(2x) 660
PFI 12 12E-3D 4ES-P	11177	7678	5348	3651	3607	5726	43.9	(1x) 30.0	25.0	(1x) 4.0	(2x) 671
PFI 12 12E-4D 1DS-O	10728	7259	5003	3651	3607	5535	43.8	(1x) 22.0	25.0	(1x) 4.0	(2x) 657
PFI 12 12E-4D 1ES-O	10624	7140	5371	3651	3607	5916	42.3	(1x) 22.0	25.0	(1x) 4.0	(2x) 665
PFI 12 12E-4D 2DS-L	11105	7505	5312	3651	3607	5535	33.8	(1x) 11.0	25.0	(1x) 4.0	(2x) 722
PFI 12 12E-4D 2ES-P	11146	7530	5688	3651	3607	5916	44.6	(1x) 30.0	25.0	(1x) 4.0	(2x) 730
PFI 12 12E-4D 3DS-P	11677	7950	5620	3651	3607	5535	43.8	(1x) 30.0	25.0	(1x) 4.0	(2x) 787
PFI 12 12E-4D 4ES-N	12040	8134	6387	3651	3607	5916	35.7	(1x) 18.5	25.0	(1x) 4.0	(2x) 875
PFI 12 12E-5D 1DS-O	11840	8064	5806	3651	3607	5726	41.9	(1x) 22.0	25.0	(1x) 4.0	(2x) 810
PFI 12 12E-5D 1ES-L	12154	8361	6164	3651	3607	6082	32.6	(1x) 11.0	25.0	(1x) 4.0	(2x) 818
PFI 12 12E-5D 2ES-P	12839	8887	6554	3651	3607	6082	42.6	(1x) 30.0	25.0	(1x) 4.0	(2x) 899
PFI 12	13003	8904	6573	3651	3607	5726	41.5	(1x)	25.0	(1x)	(2x)



12E-5D 3DS-P								30.0		4.0	972
PFI 12 12E-5D 4ES-P	14056	9745	7412	3651	3607	6082	39.2	(1x) 30.0	25.0	(1x) 4.0	(2x) 1079
PFI 12 12E-6D 1DS-M	12912	8832	6609	3651	3607	5916	35.5	(1x) 15.0	25.0	(1x) 4.0	(2x) 963
PFI 12 12E-6D 1ES-P	13398	9301	6967	3651	3607	6272	42.8	(1x) 30.0	25.0	(1x) 4.0	(2x) 971
PFI 12 18E-2D 1DS-K	13243	8712	4794	5480	3607	5631	56.4	(2x) 7.5	39.0	(1x) 5.5	(2x) 508
PFI 12 18E-2D 2DS-L	13702	9076	5044	5480	3607	5631	62.7	(2x) 11.0	39.0	(1x) 5.5	(2x) 557
PFI 12 18E-2D 2ES-K	13974	9331	5411	5480	3607	5821	52.5	(2x) 7.5	39.0	(1x) 5.5	(2x) 566
PFI 12 18E-2D 3ES-L	14442	9699	5665	5480	3607	5821	58.1	(2x) 11.0	39.0	(1x) 5.5	(2x) 616
PFI 12 18E-2D 4DS-M	14519	9675	5588	5480	3607	5631	65.0	(2x) 15.0	39.0	(1x) 5.5	(2x) 665
PFI 12 18E-2D 4ES-M	14928	10062	5974	5480	3607	5821	62.7	(2x) 15.0	39.0	(1x) 5.5	(2x) 676
PFI 12 18E-3D 1DS-L	14873	9884	5851	5480	3607	5631	60.8	(2x) 11.0	39.0	(1x) 5.5	(2x) 739
PFI 12 18E-3D 1ES-O	15509	10503	6341	5480	3607	6012	73.1	(2x) 22.0	39.0	(1x) 5.5	(2x) 747
PFI 12 18E-3D 2DS-N	15459	10320	6205	5480	3607	5631	69.2	(2x) 18.5	39.0	(1x) 5.5	(2x) 813
PFI 12 18E-3D 2ES-O	16026	10871	6709	5480	3607	6012	70.8	(2x) 22.0	39.0	(1x) 5.5	(2x) 821
PFI 12 18E-3D 3DS-N	15958	10674	6559	5480	3607	5631	66.2	(2x) 18.5	39.0	(1x) 5.5	(2x) 886
PFI 12 18E-3D 3ES-L	16412	11111	7076	5480	3607	6012	54.5	(2x) 11.0	39.0	(1x) 5.5	(2x) 895
PFI 12 18E-3D 4DS-N	16557	11100	6985	5480	3607	5631	64.4	(2x) 18.5	39.0	(1x) 5.5	(2x) 974
PFI 12 18E-3D 4ES-O	17157	11679	7516	5480	3607	6012	66.3	(2x) 22.0	39.0	(1x) 5.5	(2x) 984
PFI 12 18E-4D 1DS-N	16603	11151	7035	5480	3607	5821	68.1	(2x) 18.5	39.0	(1x) 5.5	(2x) 971
PFI 12 18E-4D 1ES-O	16439	10973	7539	5480	3607	6202	69.8	(2x) 22.0	39.0	(1x) 5.5	(2x) 978
PFI 12 18E-4D	17116	11454	8020	5480	3607	6202	67.2	(2x) 22.0	39.0	(1x) 5.5	(2x) 1076



2ES-O											
PFI 12 18E-4D 3DS-M	17901	12059	7970	5480	3607	5821	58.1	(2x) 15.0	39.0	(1x) 5.5	(2x) 1165
PFI 12 18E-4D 3ES-N	17747	11885	8496	5480	3607	6202	60.6	(2x) 18.5	39.0	(1x) 5.5	(2x) 1175
PFI 12 18E-4D 4DS-M	18691	12618	8528	5480	3607	5821	56.4	(2x) 15.0	39.0	(1x) 5.5	(2x) 1282
PFI 12 18E-4D 4ES-O	18600	12507	9072	5480	3607	6202	62.4	(2x) 22.0	39.0	(1x) 5.5	(2x) 1292
PFI 12 18E-5D 1ES-L	18659	12729	8691	5480	3607	6367	53.7	(2x) 11.0	39.0	(1x) 5.5	(2x) 1210
PFI 12 18E-5D 2ES-N	19576	13401	9280	5480	3607	6367	60.7	(2x) 18.5	39.0	(1x) 5.5	(2x) 1332
PFI 12 18E-5D 3DS-O	19940	13540	9376	5480	3607	6012	62.6	(2x) 22.0	39.0	(1x) 5.5	(2x) 1445
PFI 12 18E-6D 1DS-O	19958	13582	9417	5480	3607	6202	66.3	(2x) 22.0	39.0	(1x) 5.5	(2x) 1433
PFI 12 18E-6D 1ES-O	20435	14042	9875	5480	3607	6558	64.5	(2x) 22.0	39.0	(1x) 5.5	(2x) 1441
PFI 12 18E-6D 2DS-K	20698	14031	10106	5480	3607	6202	45.0	(2x) 7.5	39.0	(1x) 5.5	(2x) 1579
PFI 12 18E-6D 3ES-O	22419	15445	11276	5480	3607	6558	58.6	(2x) 22.0	39.0	(1x) 5.5	(2x) 1734