

TVFC_EC8022-D810_EC8A22-

S810 Adiabatische koeling

Technische gegevens

OPMERKING: Niet gebruiken voor constructie. Raadpleeg de door de fabriek gecertificeerde afmetingen & gewichten. Deze pagina bevat gegevens die actueel zijn op het moment van publicatie, die op het moment van aankoop opnieuw bevestigd moeten worden. In het belang van productverbetering kunnen specificaties, gewichten en afmetingen zonder voorafgaande kennisgeving worden gewijzigd.

Laatst bijgewerkt: 22/01/2025

TVFC_EC8022-D810_EC8A22-S810

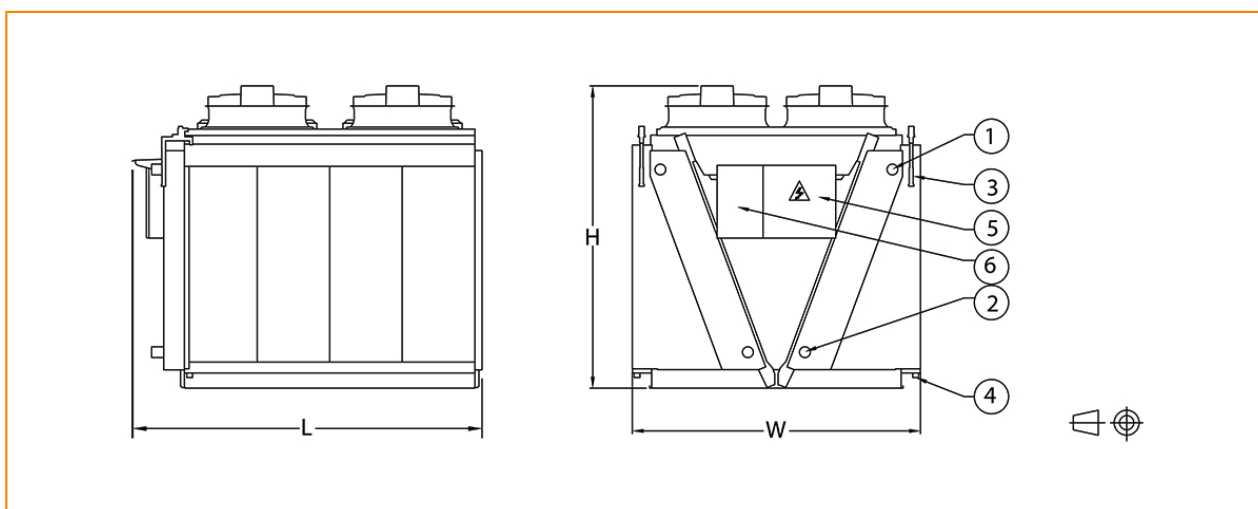

1. Vloeistofuitlaatconnectie; 2. Vloeistofinlaatconnectie; 3. Voorcoeler stadswaterconnectie; 4. Voorcoeler waterafvoer; 5. Elektrisch stroompaneel; 6. Controlepaneel.



Model	Aantal ventilatoren	Gewicht (kg)			Afmetingen (mm)			Luchtdebiet (m³/s)	Intern buisvolume (dm³)	Oppervlakte (m²)	Aansluitingen
		Bedrijfsge- wicht (kg)	Transport gewicht (kg)	Zwaarste gedeelte (kg)	L	W	H				
TVFC EC802 2-D810	4	1948	1598	1598	3097	2382	2490	24.8	240.0	1108.0	2
TVFC EC802 2-D810	4	1948	1598	1598	3097	2382	2490	24.8	240.0	1108.0	2
TVFC EC802 2-H810	4	1948	1598	1598	3097	2382	2490	24.8	240.0	1108.0	2
TVFC EC802 2-H810	4	1948	1598	1598	3097	2382	2490	24.8	240.0	1108.0	2
TVFC EC802 2-L810	4	1948	1598	1598	3097	2382	2490	24.8	240.0	1108.0	2
TVFC EC802 2-L810	4	1948	1598	1598	3097	2382	2490	24.8	240.0	1108.0	2
TVFC EC802 2-M810	4	1948	1598	1598	3097	2382	2490	24.8	240.0	1108.0	2
TVFC EC802 2-M810	4	1948	1598	1598	3097	2382	2490	24.8	240.0	1108.0	2
TVFC EC802 2-Q810	4	1948	1598	1598	3097	2382	2490	24.8	240.0	1108.0	2
TVFC EC802 2-Q810	4	1948	1598	1598	3097	2382	2490	24.8	240.0	1108.0	2
TVFC EC802 2-S810	4	1948	1598	1598	3097	2382	2490	24.8	240.0	1108.0	2
TVFC EC802 2-S810	4	1948	1598	1598	3097	2382	2490	24.8	240.0	1108.0	2
TVFC EC8A2 2-D810	4	1948	1598	1598	3097	2382	2490	22.3	240.0	1108.0	2
TVFC EC8A2 2-D810	4	1948	1598	1598	3097	2382	2490	22.3	240.0	1108.0	2
TVFC EC8A2 2-H810	4	1948	1598	1598	3097	2382	2490	22.3	240.0	1108.0	2
TVFC EC8A2 2-H810	4	1948	1598	1598	3097	2382	2490	22.3	240.0	1108.0	2
TVFC EC8A2 2-L810	4	1948	1598	1598	3097	2382	2490	22.3	240.0	1108.0	2
TVFC EC8A2 2-L810	4	1948	1598	1598	3097	2382	2490	22.3	240.0	1108.0	2
TVFC	4	1948	1598	1598	3097	2382	2490	22.3	240.0	1108.0	2



EC8A2 2-M810											
TVFC EC8A2 2-M810	4	1948	1598	1598	3097	2382	2490	22.3	240.0	1108.0	2
TVFC EC8A2 2-Q810	4	1948	1598	1598	3097	2382	2490	22.3	240.0	1108.0	2
TVFC EC8A2 2-Q810	4	1948	1598	1598	3097	2382	2490	22.3	240.0	1108.0	2
TVFC EC8A2 2-S810	4	1948	1598	1598	3097	2382	2490	22.3	240.0	1108.0	2
TVFC EC8A2 2-S810	4	1948	1598	1598	3097	2382	2490	22.3	240.0	1108.0	2