



PLC2 xxx-0812E-K

Verdampingscondensors

Technische gegevens

REMARK: Do not use for construction. Refer to factory certified dimensions & weights. This page includes data current at time of publication, which should be reconfirmed at the time of purchase. In the interest of product improvement, specifications, weights and dimensions are subject to change without notice.

General notes

1. Standard refrigerant in- and outlet connection sizes are ND100. Consult your local BAC representative for locations. Refrigerant connections are closed and coils are filled with an inert gas.
2. Unit height is indicative. For precise value refer to certified print.
3. Shipping/operating weights indicated are for units without accessories such as sound attenuators, discharge hoods, etc. Consult factory certified prints to obtain weight additions and the heaviest section to be lifted. Operating weights shown in the tables is based on total unit weight, weight of refrigerant operating charge and basin filled to overflow level.
4. Drawings show the standard right hand arrangement (air inlet side on the right when facing the connection end). Left hand arrangement can be supplied upon request.

Laatst bijgewerkt: 08/01/2025

PLC2 xxx-0812E-K

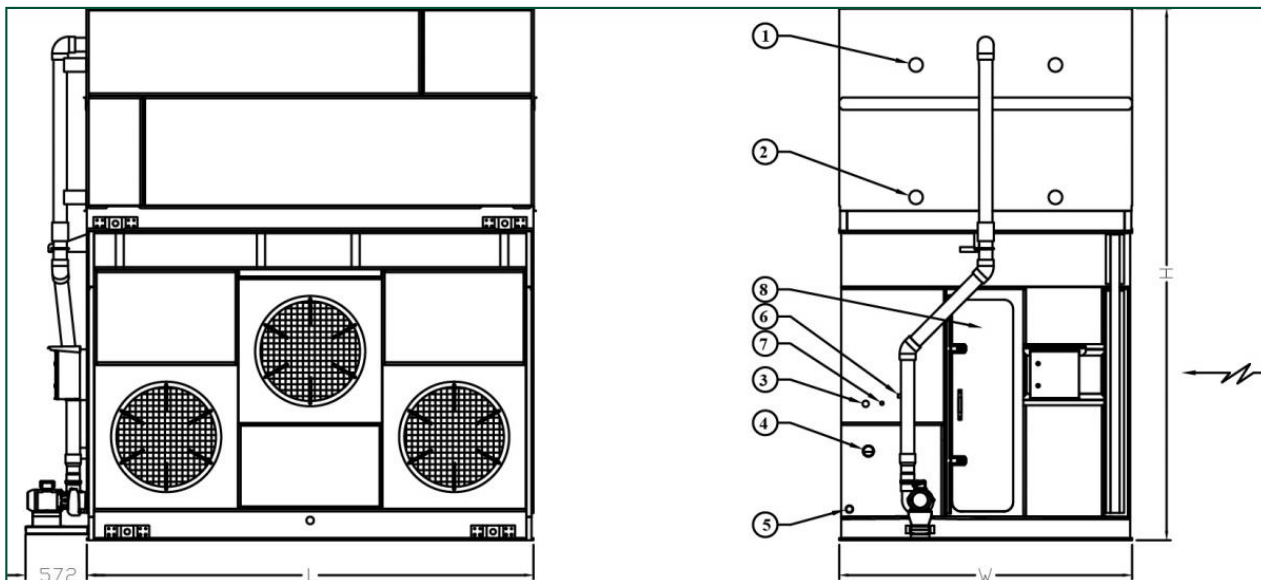

1. Koelmiddel in ND100; 2. Koelmiddel uit ND100; 3. Make-up ND40; 4. Overloop ND80; 5. Afvoer ND50; 6. Spui ND25; 7. Behandeld water in ND20; 8. Toegangsdeur.



Model	Gewicht (kg)			Afmetingen (mm)			Luchtdebi et (m ³ /s)	Ventilator motor (kW)	Sproeiwat erdebiet (l/s)	Pompmot or (kW)	R717-ladi ng (kg)
	Bedrijfsge wicht (kg)	Transport gewicht (kg)	Zwaarste gedeelte (kg)	L	W	H					
PLC2 0248-0 812E-K	6141	4786	2550	3651	2469	4353	31.65	(3x) 7.0	21.6	(1x) 2.2	100.0
PLC2 0276-0 812E-K	6682	5296	3060	3651	2469	4353	30.23	(3x) 7.0	21.6	(1x) 2.2	132.0
PLC2 0305-0 812E-K	7350	5932	3696	3651	2469	4734	28.81	(3x) 7.0	21.6	(1x) 2.2	164.0
PLC2 0330-0 812E-K	7892	6442	4206	3651	2469	4734	27.4	(3x) 7.0	21.6	(1x) 2.2	196.0