

# PCE L177 - L314

## Verdampingscondensors

### Technische gegevens

**Opmerking:** Gebruik niet voor constructie. Raadpleeg de door de fabriek gecertificeerde afmetingen en gewichten. Deze pagina bevat gegevens die actueel zijn op het moment van publicatie, die op het moment van aankoop opnieuw moeten worden bevestigd. In het belang van productverbetering kunnen specificaties, gewichten en afmetingen zonder voorafgaande kennisgeving worden gewijzigd.

**Laatst bijgewerkt:** 22/01/2025

### PCE L177 - L314

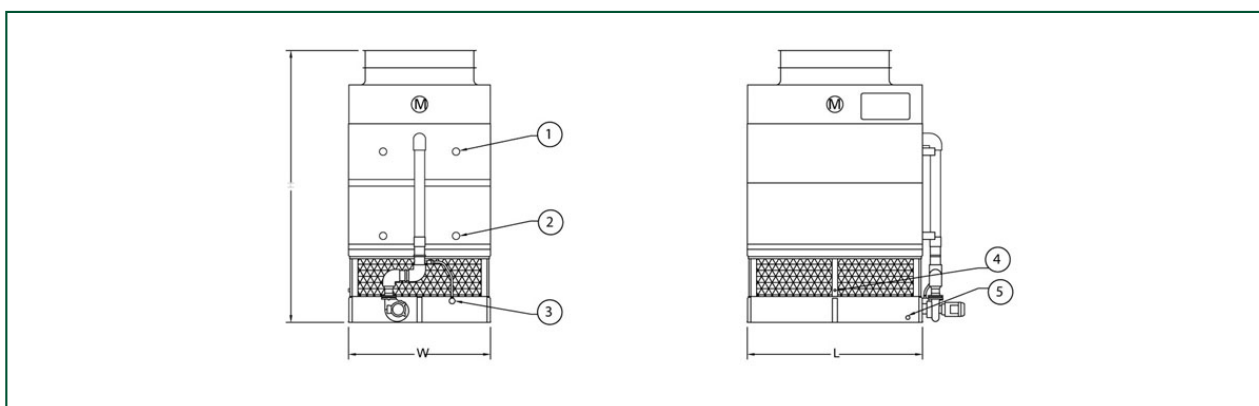

1. Vloeistof in; 2. Vloeistof uit; 3. Overloop; 4. Make up; 5. Afloop.



Model	Gewicht (kg)			Afmetingen (mm)			Luchtdebi et (m <sup>3</sup> /s)	Ventilator motor (kW)	Sproeiwat erdebiet (l/s)	Pompmot or (kW)	R717-ladi ng (kg)
	Bedrijfsge wicht (kg)	Transport gewicht (kg)	Zwaarste gedeelte (kg)	L	W	H					
PCE 177-L- L	5521	3973	2929	2737	2997	4475	24.88	(1x) 11.0	30.0	(1x) 4.0	136.0
PCE 189-M- L	5530	3982	2929	2737	2997	4475	27.18	(1x) 15.0	30.0	(1x) 4.0	136.0
PCE 199-N- L	5594	4046	2929	2737	2997	4475	29.1	(1x) 18.5	30.0	(1x) 4.0	136.0
PCE 194-L- L	6134	4559	3514	2737	2997	4710	23.6	(1x) 11.0	30.0	(1x) 4.0	168.0
PCE 208-M- L	6143	4568	3514	2737	2997	4710	25.75	(1x) 15.0	30.0	(1x) 4.0	168.0
PCE 219-N- L	6207	4631	3514	2737	2997	4710	27.56	(1x) 18.5	30.0	(1x) 4.0	168.0
PCE 206-L- L	6756	5149	4105	2737	2997	4945	22.55	(1x) 11.0	30.0	(1x) 4.0	202.0
PCE 211-L- L	7097	5467	4422	2737	2997	4945	21.4	(1x) 11.0	30.0	(1x) 4.0	224.0
PCE 221-M- L	6765	5158	4105	2737	2997	4945	24.61	(1x) 15.0	30.0	(1x) 4.0	202.0
PCE 226-M- L	7106	5476	4422	2737	2997	4945	23.36	(1x) 15.0	30.0	(1x) 4.0	224.0
PCE 233-N- L	6829	5221	4105	2737	2997	4945	26.33	(1x) 18.5	30.0	(1x) 4.0	202.0
PCE 238-N- L	7169	5539	4422	2737	2997	4945	25.0	(1x) 18.5	30.0	(1x) 4.0	224.0
PCE 217-L- L	7768	6107	5063	2737	2997	5180	20.57	(1x) 11.0	30.0	(1x) 4.0	240.0
PCE 234-M- L	7778	6116	5063	2737	2997	5180	22.43	(1x) 15.0	30.0	(1x) 4.0	240.0
PCE 247-N- L	7841	6179	5063	2737	2997	5180	24.0	(1x) 18.5	30.0	(1x) 4.0	240.0
PCE 230-M- L	7037	4976	3705	3651	2997	4551	32.41	(1x) 15.0	40.0	(1x) 4.0	180.0
PCE 242-N- L	7101	5040	3705	3651	2997	4551	34.72	(1x) 18.5	40.0	(1x) 4.0	180.0
PCE 252-O- L	7124	5063	3705	3651	2997	4551	36.71	(1x) 22.0	40.0	(1x) 4.0	180.0
PCE	7841	5739	4468	3651	2997	4786	30.87	(1x)	40.0	(1x)	218.0



253-M-L								15.0		4.0	
PCE 267-N-L	7905	5803	4468	3651	2997	4786	33.04	(1x) 18.5	40.0	(1x) 4.0	218.0
PCE 279-O-L	7927	5825	4468	3651	2997	4786	34.96	(1x) 22.0	40.0	(1x) 4.0	218.0
PCE 270-M-L	8645	6502	5231	3651	2997	5021	29.6	(1x) 15.0	40.0	(1x) 4.0	250.0
PCE 275-M-L	9112	6942	5671	3651	2997	5021	28.19	(1x) 15.0	40.0	(1x) 4.0	308.0
PCE 284-N-L	8708	6565	5231	3651	2997	5021	31.68	(1x) 18.5	40.0	(1x) 4.0	250.0
PCE 291-N-L	9176	7006	5671	3651	2997	5021	30.19	(1x) 18.5	40.0	(1x) 4.0	308.0
PCE 297-O-L	8731	6588	5231	3651	2997	5021	33.49	(1x) 22.0	40.0	(1x) 4.0	250.0
PCE 304-O-L	9199	7028	5671	3651	2997	5021	31.91	(1x) 22.0	40.0	(1x) 4.0	308.0
PCE 285-M-L	9993	7778	6506	3651	2997	5256	27.15	(1x) 15.0	40.0	(1x) 4.0	346.0
PCE 301-N-L	10057	7841	6506	3651	2997	5256	29.05	(1x) 18.5	40.0	(1x) 4.0	346.0
PCE 314-O-L	10079	7864	6506	3651	2997	5256	30.68	(1x) 22.0	40.0	(1x) 4.0	346.0