

S15E 0809-06

Open koeltorens

Technische gegevens

REMARK: Do not use for construction. Refer to factory certified dimensions & weights. This page includes data current at time of publication, which should be reconfirmed at the time of purchase. In the interest of product improvements, specifications, weights and dimensions are subject to change without notice.

General notes

1. All connections 100 mm and smaller are MPT. Connections 125 mm and larger are beveled-for-welding.
2. Make up, overflow, suction and drain connections can be provided on end opposite to that shown; consult your BAC representative.
3. Models 1012-09 thru 1012-10, 1018-09 thru 1018-10, 1212-09 thru 1212-12 and 1218-09 thru 1218-12 are shipped in two sections per cell. The top section heights are for model 1012-09 thru 1012-10 and 1212-09 thru 1212-12, 2501 mm. For models 1018-09 thru 1018-10 and 1218-09 thru 1218-12, 2562 mm.

[S1500E cooling tower performance at standard conditions](#)

Laatst bijgewerkt: 01/09/2024

S15E 0809-06

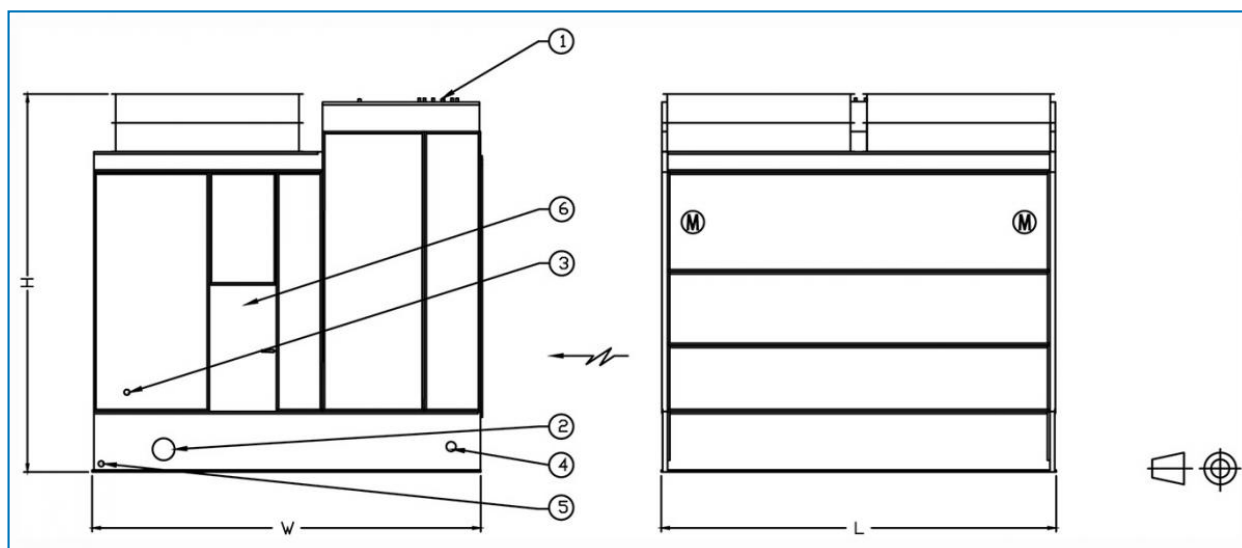

1. Water in; 2. Water uit; 3. Make-up; 4. Overloop ND80; 5. Afvoer ND50; 6. Toegangsdeur.



Model	Gewicht (kg)			Afmetingen (mm)			Luchtdebi et (m ³ /s)	Ventilator motor (kW)	Vloeistofi nlaat ND (mm)	Vloeistofu itlaat ND (mm)	Suppletie ND (mm)
	Bedrijfsge wicht (kg)	Transport gewicht (kg)	Zwaarste gedeelte (kg)	L	W	H					
S15E 0809-0 6GE	3356	1719	1719	2737	2394	3336	17.0	(3x) 2.2	(1x) 200	(1x) 200	(1x) 40
S15E 0809-0 6HE	3365	1728	1728	2737	2394	3336	20.0	(3x) 4.0	(1x) 200	(1x) 200	(1x) 40