



**BALTIMORE
AIRCOIL COMPANY**



PLC3 Evaporative Condensers

OPERATING AND MAINTENANCE INSTRUCTIONS





Recommended maintenance and monitoring programme

Baltimore Aircoil Company equipment needs to be properly installed, operated and maintained. Documentation of the equipment used, including a drawing, technical data sheet and this manual should be kept on record. To achieve long, trouble-free and safe operation, it is necessary to establish an operating plan including a programme of regular inspection, monitoring and maintenance. All inspections, maintenance and monitoring actions should be recorded in a cooling system logbook. The operating and maintenance instructions published here can be used as a guide to achieve these goals.

In addition to establishing the operating plan and the cooling system logbook it is recommended to conduct a cooling system risk analysis, preferably by an independent third party.

For the cooling system, scale, corrosion and biological control must be established and initiated when the system is first filled with water and administered on a regular basis thereafter in accordance with recognized Codes of Practice, (such as EUROVENT 9 - 5/6, ACOP HSC L8, Guide des bonnes pratiques, Legionella et tours aéroréfrigérantes, etc.). Water sampling, test results and corrective actions should be recorded in the cooling system logbook.

For more specific recommendations on keeping your cooling system efficient and safe, contact your local BAC service provider or representative. Name, e-mail and phone number can be found on the website www.BACService.eu.

Checks and adjustments	Start-Up	Weekly	Monthly	Quarterly	Every 6 months	Annually	Shutdown
Cold water basin & strainer	X			X			
Water wall							
Operating level and make-up	X		X				
Blow down	X		X				
Sump heater package	X				X		
Rotation of fan(s) and pump(s)	X						
Fan guards	X						
Motor voltage and current	X					X	
Electrical connections	X				X		
Unusual noise and/or vibration	X		X				

Inspections and monitoring	Start-Up	Weekly	Monthly	Quarterly	Every 6 months	Annually	Shutdown
General condition	X		X				
Heat transfer section	X				X		
Drift eliminators	X				X		
Water distribution	X				X		
Water collection	X				X		
Fan and motor	X			X			
Electric water level control package	X				X		
TAB test (dip slides)	X	X					
Circulating water quality	X		X				
System overview	X					X	
Record keeping	as per event						



Cleaning procedures	Start-Up	Weekly	Monthly	Quarterly	Every 6 months	Annually	Shutdown
Mechanical cleaning	X					X	X
Disinfection**	(X)					(X)	(X)
Drain basin and pump							X

** depends on applied code of practice

Notes

1. Water treatment and auxiliary equipment integrated in the cooling system may require additions to the table above. Contact suppliers for recommended actions and their required frequency.
2. Recommended service intervals are for typical installations. Different environmental conditions may dictate more frequent servicing.
3. When operating in ambient temperatures below freezing, the unit should be inspected more frequently (see Cold weather operations in the appropriate Operating and Maintenance Instructions).



Table of contents

OPERATING AND MAINTENANCE INSTRUCTIONS

2	Construction Details	5
3	General information	6
	Operating conditions	6
	Connecting pipework	6
	Safety precautions	7
	Disposal requirements	8
	Non-walking surfaces	8
	Modifications by others	8
	Warranty	9
4	Water Care	10
	About water care	10
	Biological control	12
	Chemical treatment	12
	Passivation	13
	Overflow connection	13
5	Fan Motor Communication	14
	Introduction	14
	EC Fans controlled through 0-10V signal	14
	PM Fans controlled through 0-10V signal	15
	Specific Functions	15
	7 kW EC Fan Motor Modbus Communication	16
	15 kW PM Fan Motor Modbus Communication	22
6	Cold Weather Operations	26
	About cold weather operation	26
	Protection against sump water freezing	26
	Capacity control	26
	Operating Logic	27
7	Maintenance Procedure	28
	Checks and adjustments	28
	Inspections and corrective actions	31
	Cleaning procedures	35
8	Comprehensive Maintenance	37
	About comprehensive maintenance	37
	Prolonged outdoor stay	37
9	Further Assistance & Information	38
	The service expert for BAC equipment	38
	More information	38

PLC3 CONSTRUCTION DETAILS



- | | |
|---------------------------------------|---|
| 1. Drift eliminators | 10. Water wall |
| 2. Spray branches | 11. Electrical water level controller (not visible) |
| 3. Spray nozzles | 12. Cold water basin |
| 4. Coil(s) | 13. Radial fan direct drive system |
| 5. Coil inlet connections | 14. Fan guard |
| 6. Coil outlet connections | 15. Fan inlet ring |
| 7. DiamondClear® Water Capture System | 16. Access door |
| 8. Spray pump | 17. Terminal box |
| 9. Strainer (not visible) | |

Operating conditions

BAC cooling equipment is designed for the operating conditions specified below, which must not be exceeded during operation.

- **Wind Load:** For safe operation of unshielded equipment exposed to wind speeds above 120 km/h installed at a height above 30 m from the ground, contact your local BAC representative.
- **Seismic Risk:** For safe operation of equipment installed in moderate and high hazard area's contact your local BAC representative.

Standard electrical motors / electrical water level controls are suitable for an ambient temperature range from -25°C to +40°C.

- Design pressure: 23 bar (std.) or 28 bar (option) according to PED
- Refrigerant inlet temperature: max. 120°C
- Refrigerant outlet temperature: min. -20°C
- Suitable refrigerants: Natural refrigerants (R-717, R-1270), Halocarbon refrigerants, HFC`s.

Standard condenser coils are manufactured from black steel and hot dip galvanised after fabrication and may contain certain contaminants, such as carbon, iron oxide or welding particles. The interior condition of the coil, including humid air must be considered, when using halocarbon (or HFC) refrigerants and sensitive system components, such as electronic expansion devices or semi hermetic compressors. The installer must take the necessary precautions on site to safeguard the operation of these components in conjunction with the condenser coils.

Maximum spray pressure: 14 kPa (If pump(s) are installed by others, it is recommended to install a pressure gauge at the inlet of the water distribution system.)

At ambient temperatures above 40°C ensure spray water pump remains running, even if condenser is idle. This prevents unwanted discharge of refrigerant through safety valves (by others).



Stand-by pump arrangements for evaporative condensers require alternating operation of each pump at least twice per week to avoid stagnant water conditions and bacteriological growth.

PURGE REQUIREMENTS

The installer of BAC condensers must ensure proper air purging of the system prior to operation.

Entrained air can obstruct free drainage of refrigerant and reduce condensing capacity, resulting in higher operating pressures than designed.

All connections (installed by others) must be leak free and tested accordingly.

To verify absence of non condensables in the refrigeration system, follow the instructions in the BAC Application Handbook – EU Edition (<https://www.baltimoreaircoil.eu/downloads/pdf-Application-Handbook-EU-Edition>), Section "Condenser Engineering Guidelines".

Connecting pipework

All piping external to BAC cooling equipment must be supported separately.

In case the equipment is installed on vibration rails or springs, the piping must contain compensators to eliminate vibrations carried through the external pipework.

Suction pipe sizing should be done according to good practice, which may for larger flows require larger pipe diameters than the outlet connection. In such cases adapter pieces need to be installed.

Safety precautions

All electrical, mechanical and rotating machinery constitutes a potential hazard, particularly for those not familiar with its design, construction and operation. Accordingly, adequate safeguards (including use of protective enclosures where necessary) should be taken with this equipment both to safeguard the public (including minors) from injury and to prevent damage to the equipment, its associated system and the premises. If there is doubt about safe and proper rigging, installation, operation or maintenance procedures, contact the equipment manufacturer or his representative for advice.

When working on operating equipment, be aware that some parts may have an elevated temperature. Any operations on elevated level have to be executed with extra care to prevent accidents.



CAUTION

Do not cover units with PVC eliminators with a plastic tarpaulin. Temperature increase due to sun radiation could deform the eliminators.

AUTHORIZED PERSONNEL

The operation, maintenance and repair of this equipment should be undertaken only by personnel authorized and qualified to do so. All such personnel should be thoroughly familiar with the equipment, the associated systems and controls and the procedures set forth in this and other relevant manuals. Proper care, personal protective equipment, procedures and tools must be used in handling, lifting, installing, operating, maintaining and repairing this equipment to prevent personal injury and/or property damage. Personnel must use personal protective equipment where necessary (gloves, ear plugs, etc...)

MECHANICAL SAFETY

Mechanical safety of the equipment is in accordance with the requirements of the EU machinery directive. Depending upon site conditions it also may be necessary to install items such as bottom screens, ladders, safety cages, stairways, access platforms, handrails and toe boards for the safety and convenience of the authorized service and maintenance personnel.

At no time this equipment should be operated without all fan screens, access panels and access doors in place/closed and properly secured.

When the equipment is operated with a variable fan speed control device, steps must be taken to avoid operating at or near to the fan's «critical speed».

Since the equipment operates at variable speeds, steps must be taken to avoid operating at or near the installation's "critical speed".

For more information consult your local BAC representative.



ELECTRICAL SAFETY

All electrical components associated with this equipment should be installed with a lockable disconnect switch located within sight of the equipment.

In the event of multiple components, these can be installed after a single disconnect switch but multiple switches or a combination thereof are also allowed.

No service work should be performed on or near electrical components unless adequate safety measures are taken. These include, but are not limited to the following:

- Isolate the component electrically
- Lock the isolation switch in order to prevent unintentional restart
- Measure that no electrical voltage is present any more
- If parts of the installation remain energized, make sure to properly demarcate these in order to avoid confusion

Fan motor terminals and connections may have residual voltage after unit shut-down. Wait five minutes after disconnecting the voltage at all poles before opening the fan motor terminal box.

LOCATION

All cooling equipment should be located as far away as possible from occupied areas, open windows or air intakes to buildings.

LOCAL REGULATIONS

Installation and operation of cooling equipment may be subject to local regulations, such as establishment of risk analysis. Ensure regulatory requirements are consistently met.

Disposal requirements

Dismantling of the unit and treatment of refrigerants (if applicable), oil and other parts must be done with respect to the environment whilst protecting workers from potential risks related to exposure to harmful substances.

National and regional legislation for material disposal and protection of workers should be taken into account with regard to:

- Appropriate handling of construction and maintenance materials when dismantling the unit. In particular when dealing with materials that contain harmful substances, such as asbestos or carcinogenic substances.
- Appropriate disposal of the construction and maintenance materials and components such as steel, plastics, refrigerants and waste water according to local and national requirements for waste management, recycling and disposal.

Non-walking surfaces

Access to and maintenance of any component needs to be performed in accordance with all local applicable laws and regulations. If the proper and required access means are not present, temporary structures need to be foreseen. Under no circumstance can one use parts of the unit, that are not designed as an access mean, unless measures can be taken to mitigate any risks that might occur from doing so.

Modifications by others

Whenever modifications or changes are made by others to the BAC equipment without written permission of BAC, the party who has done the modification becomes responsible for all consequences of this change and BAC declines all liability for the product.

Warranty

BAC will guarantee all products to be free from manufactured defects in materials and workmanship for a period of 24 months from the date of shipment. In the event of any such defect, BAC will repair or provide a replacement. For more details, please refer to the Limitation of Warranties applicable to and in effect at the time of the sale/purchase of these products. You can find these terms and conditions on the reverse side of your order acknowledgement form and your invoice.



About water care

In all cooling equipment, operating in evaporative mode, the cooling is accomplished by evaporating a small portion of the re-circulating water as it flows through the equipment. When this water evaporates, the impurities originally present in the water remain. Unless a small amount of water is drained from the system, known as blow down, the concentration of dissolved solids will increase rapidly and lead to scale formation or corrosion or both. Also, since water is being lost from the system through evaporation and blow down, this water needs to be replenished.

The total amount of replenishment, known as make-up, is defined as:

Make-up = evaporation loss + blow down

In addition to the impurities present in the make-up water, any airborne impurities or biological matter are carried into the equipment and drawn into the re-circulating water. Over and above the necessity to blow down a small quantity of water, a water treatment programme specifically designed to address scale, corrosion and biological control should be initiated when the system is first installed and maintained on a continuous base thereafter. Moreover there must be an ongoing programme of monitoring in place to ensure the water treatment system is maintaining the water quality within the control guidelines.

Check and adjustments of blow down depends on the blow down device actual in use.

To prevent excessive build-up of impurities in the circulating water, a small amount of water must be « bled » from the system at a rate to be determined by the water treatment regime. The amount of blow down is determined by the design cycles of concentration for the system. These cycles of concentration depend on the quality of the make-up water and the design guidelines for the quality of the recirculating water given below.

Make-up water to the evaporative unit should have minimum 30 ppm hardness as CaCO_3 .

Where use of a softener is necessary to achieve this, the supply to the evaporative unit should not be totally softened, but blended with the incoming unsoftened water to achieve the minimum hardness between 30 and 70 ppm as CaCO_3 .

Maintaining a minimum hardness in the make-up water offsets the corrosive properties of totally softened water and reduces the reliance on corrosion inhibitors to protect the system.

To control corrosion and scale, the water chemistry of the circulated water has to be kept within the water quality guidelines of the specific materials of construction used, as listed in the following table(s).

	Baltibond® Hybrid Coating and SST304L
pH	6.5 to 9.2
Total hardness (as CaCO ₃)	50 to 750 mg/l
Total alkalinity (as CaCO ₃)	600 mg/l max.
Total dissolved solids	2050 mg/l max.
Conductivity	3300 µS/cm
Chlorides	300 mg/l max.
Sulfates*	350 mg/l max.*
Total suspended solids	25 mg/l max.
Chlorination (as free chlorine / halogen): continuous	1.5 mg/l max.
Chlorination (as free chlorine / halogen): batch dosing for cleaning & disinfection	5-15 mg/l max. for 6 hours max. 25 mg/l max. for 2 hours max. 50 mg/l max. for 1 hour max.

Circulated water quality guidelines for Baltibond® Hybrid Coating

***Note:** Higher concentration of sulfates is allowed, provided the sum of chlorides + sulfates parameters does not exceed 650 mg/l for Baltibond®/SST304L.

***Note:** In case of a HDG coil, passivation of the coil is required. During this period, both the pH and the hardness of the spray water will have more stringent requirements. The pH must be kept between 7 and 8.2, and the hardness must be kept between 100 and 300 ppm.

	SST304L SST316L with HDG coil	SST316L
pH	6.5 to 9.2	6.5 to 9.5
Total hardness (as CaCO ₃)	50 to 750 mg/l	0 to 750 mg/l
Total alkalinity (as CaCO ₃)	600 mg/l max.	600 mg/l max.
Total dissolved solids	2050 mg/l max.	2500 mg/l max.
Conductivity	3300 µS/cm	4000 µS/cm
Chlorides	300 mg/l max.	750 mg/l max.
Sulfates*	350 mg/l max.*	750 mg/l max.*
Total suspended solids	25 mg/l max.	25 mg/l max.
Chlorination (as free chlorine/halogen): continuous	1,5 mg/l max.	2 mg/l max.
Chlorination (as free chlorine/halogen): batch dosing for cleaning & disinfection	5-15 mg/l max. for 6 hours max. 25 mg/l max. for 2 hours max. 50 mg/l max. for 1 hour max.	5-15 mg/l max. for 6 hours max. 25 mg/l max. for 2 hours max. 50 mg/l max. for 1 hour max.

Circulated water quality guidelines for Stainless Steel

***Note:** Higher concentration of sulphates is allowed provided the sum of chlorides + sulphates parameters does not exceed 650 mg/l for SST304L and 1500 mg/l for SST316L.

***Note:** In case of a HDG coil, passivation of the coil is required. During this period, both the pH and the hardness of the spray water will have more stringent requirements. The pH must be kept between 7 and 8.2, and the hardness must be kept between 100 and 300 ppm.



For Ozone water treatment application:

- Stainless steel 316L execution is required.
- Ozone levels are to be maintained to 0.2 ppm \pm 0.1 ppm for at least 90% of the time, with absolute maximum peaks of 0.5 ppm

Cycles of concentration are the ratio of the dissolved solids concentration in the circulating water compared to the dissolved solids concentration in the make-up water. The blow down rate can be calculated as follows:

$$\text{Blow down} = \text{Evaporation loss} / (\text{Cycles of concentration} - 1)$$

The evaporation loss is not only function of the heat load but also depends on climatic conditions, the type of equipment used and the method of capacity control, which is applied. The evaporation loss at summer conditions is approximately 0.431 l/ 1000 kJ heat rejection. This number should be used for blow down valve sizing only and not for the calculation of annual water consumption.

Biological control

The growth of algae, slimes and other micro-organisms, if uncontrolled, will reduce system efficiency and may contribute to the growth of potentially harmful micro-organisms, such as Legionella, in the recirculating water system.

Accordingly a treatment programme specifically designed to address biological control should be initiated when the system is first filled with water and administered on a regular base thereafter in accordance with any regulations (national, regional) that may exist or in accordance with accepted codes of good practice, such as EUROVENT 9-5/6, VDMA Detailsheet 24649 etc.

Also during shutdown periods it is recommended to continue the water treatment programme. Alternatively, the basin and pump should be drained.

It is strongly recommended to monitor the bacteriological contamination of the recirculating water on a regular base (for example, TAB test with dip slides on a weekly base) and record all results.

Certain products used for water treatment, particular some dispersant and bio-dispersant additives, might change the properties of the water (such as the surface tension), which can cause excessive drift loss (water passing through the eliminators). In such case we recommend to review the water treatment (product type, dosage) with your water treatment expert.

In case of doubt, a short test can be performed, after cleaning & disinfection, using fresh water without addition of the concerned chemical (within the limits of the local legislation).

Chemical treatment

1. Water treatment chemicals or non-chemical systems need to be compatible with the materials of construction used in the cooling system including the evaporative cooling equipment itself.
2. In case of chemical water treatment, chemicals should be added to the recirculating water by an automatic feed system. This will prevent localised high concentrations of chemicals, which may cause corrosion. Preferably the water treatment chemicals should be fed into the cooling system at the discharge of the recirculation pump. The chemicals should not be fed in concentrated form, nor batch fed directly into the cold water sump of the evaporative cooling equipment.
3. BAC specifically discourages acid dosing as mean of scale control (unless under certain strict circumstances for open circuit cooling towers with very large system volume and remote sump, or constructed from stainless steel).
4. A competent water treatment company should be consulted for the specific water treatment programme to be applied. Next to the supply of dosing and control equipment and chemicals, the programme should include regular monthly monitoring of the circulating and make up water quality.

5. If it is proposed to operate a treatment programme outside the BAC Water Quality Control Guidelines, the BAC factory warranty may be invalidated if the water quality is persistently outside the Control Guidelines, unless specific prior written BAC approval. (Some parameters may be exceeded under certain strict circumstances.)

It is strongly recommended to check the key parameters of the circulating water quality on a monthly base. See table: "Circulated water quality guidelines". All test results need to be recorded.

Passivation

When new systems are first commissioned, special measures should be taken to ensure that galvanized steel surfaces are properly passivated to provide maximum protection from corrosion. **Passivation** is the formation of a protective, passive, oxide layer on galvanized steel surfaces.

To ensure that galvanized steel surfaces are passivated, the pH of circulating water should be kept between 7.0 and 8.2 and calcium hardness between 100 and 300 ppm (as CaCO_3) for four to eight weeks after start-up, or until new zinc surfaces turn dull grey in colour. If white deposits form on galvanized steel surfaces after the pH is returned to normal service levels, it may be necessary to repeat the passivation process.

 Full stainless steel units and units protected by the Baltibond[®] hybrid coating do not require passivation. An exception to this are units with a galvanized steel coil bundle which do still require the proper passivation procedure as described here in this section.

In case you can't keep the pH below 8.2, a secondary approach is to conduct a chemical passivation using inorganic phosphate or film-forming passivation agents. Consult your water treatment specialist for specific recommendation.

Overflow connection

A slight loss of water through the overflow on forced draft units is normal when the fans are in operation, since the unit is in overpressure and some saturated air will be blown out to the unit, carrying several droplets of water.

Introduction

The basis for the air movement system of a Polairis™ unit are direct driven radial fans.

LEPLC3-XXE-XXX-KE	Electronically commutated fan motor	EC
PLC3-XXE-XXX-MP	Permanent magnet fan motor	PM
PLC3-XXE-XXX-MD	Alternating current fan motor	AC

When standing in front of the unit:

- the PM and AC fans rotate counterclockwise
- the EC fans rotate clockwise

Each EC/PM motor has an individual integrated speed controller, which can be piloted either through an analog 0-10V signal or over a digital bus system (Modbus RS485). Both can't be used simultaneously and hence a choice between the one or the other has to be made.

In addition to controlling the fan speed – and hence the capacity of the unit – the digital bus system allows to extract additional information (see below).

EC Fans controlled through 0-10V signal

In case of 0-10V control without error contact option, no alarms or warnings are available.

In case of 0-10V control with error contact option, the following alarm will be detected:

- braking mode: set in case of external drive in opposite direction at high speed for lengthy period
- actual speed is lower than running monitoring speed limit
- open circuit at analog input or PMW input for set value

The fan speed will be proportional with the input voltage. At 0V fans will run at about 40 rpm if the space heater function for the 7 kW EC fan is enabled and 400V power supply is connected. At 10V the fans will run at maximum speed. The maximum speed of the fan is indicated in the submittal package on the Polairis™ Set Up sheet.

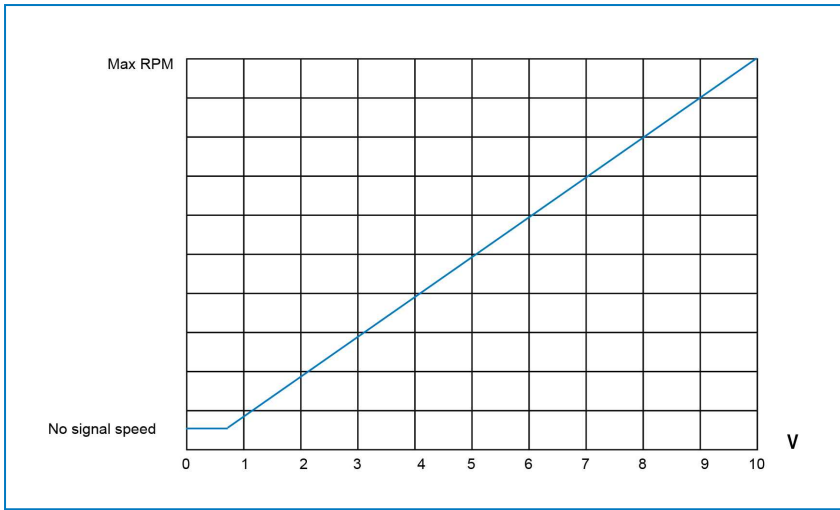

PM Fans controlled through 0-10V signal

In case of 0-10V control without error contact option, no alarms or warnings are available. The fan speed will be proportional with the input voltage. The speed is controlled by analog voltage input. When AI0 receives voltage $<0.5V$ the fans will stop; when AI0 receives voltage $\geq 0.5V$ the fans start to rotate. Speed is linear to voltage between 0.5V to 10V.

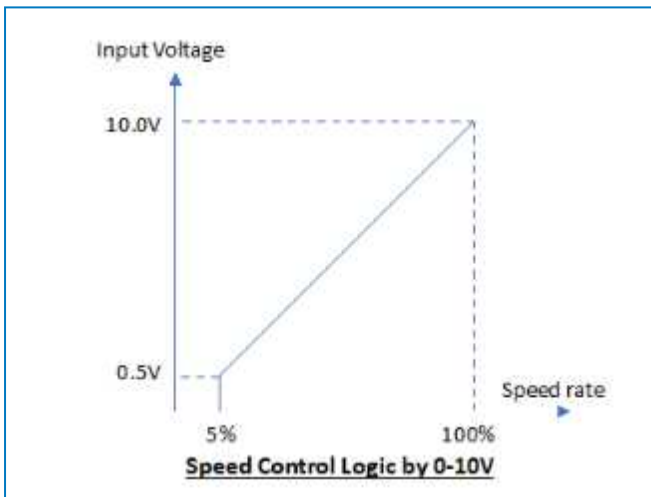

Specific Functions

SPECIFIC FUNCTIONS

The integrated speed controller of each EC or PM motor contains the following specific functions (activated by default for 0-10V as well as ModBus RS485 control).

SPACE HEATER FUNCTION

7 kW EC fan

For an EC fan, it is mandatory to keep the fan energized when not in operation.



When no heat rejection is required and a '0' signal is sent to the motors, they will keep running at a pre-set minimum speed of about 40 rpm. This prevents condensation to form inside the motor through the heat dissipated from the windings. Additionally, through the constant movement, the bearings will be protected from pre-mature damage, maximizing the overall motor service life.

This function can be disabled by enabling parameter D112 over the digital bus system. However, it is strongly recommended to keep this function activated.

15 kW fan PM

These fan motors are equipped with space heaters which must be activated when the motor is idle. The space heater keeps the internal temperature of the motor above the ambient dew point while the motor is off, preventing condensation inside the motor.

SHEDDING FUNCTION

The shedding function is intended to enable a fan with fan blades that have frozen into place to shed the motor free by attempting to start the fan in both directions in alternation. During this process, the modulation level is increased during each attempt. The first attempt begins with the standard starting modulation level and the desired direction of rotation. If this does not succeed in getting the fan rotating, during each additional attempt, the direction of rotation is reversed and the starting modulation level is increased by 5%, up to a value no higher than allowed in order to prevent damage to the fan. At the same time, a shedding function warning is generated.

7 kW EC Fan Motor Modbus Communication

ALARMS AND WARNINGS

Fans controlled over ModBus RS485

Following alarms are available over the bus system:

UzLow	DC-link under voltage
RL_Cal	Rotor position sensor calibration error
n_Limit	Speed limit exceeded
BLK	Locked motor
HLL	Hall sensor error
TFM	Motor overheated
FB	Fan bad (general error, set for every error that occurs)
SKF	Communication error between master controller and slave controller
TFE	Power module overheated
PHA	Phase failure

If an alarm is detected, the motor will be stopped and only start again after the error has been resolved.

The following warnings are available over the bus system:

LRF:	Shedding function active (see also shedding function)
UeHigh:	Supply voltage high
OpenCir.:	Open circuit at analog input or PWM input for the set value (voltage at analog input < open circuit limit value, or signal at PWM input statistically high)
n_Low:	Actual speed is lower than speed limit for running monitoring
RL_Cal:	Calibration of rotor position sensor in progress
UzHigh:	DC-link voltage high
Brake:	Brake operation: set if an external force drives the motor in opposite direction with high speed for a prolonged period.
UzLow:	DC-link voltage low
TEI_high:	Electronics interior temperature high
TM_high:	Motor temperature high
TE_high:	Output stage temperature high
P_Limit:	Power limitation activated
L_high:	Line impedance too high (DC-link voltage unstable)
I_Limit:	Current limitation activated

When a warning is detected, the motor remains in operation.

BMS COMMUNICATION

Settings

The different fan motors can be integrated in a BMS system through ModBus RS485. The main PLC needs to be configured as a ModBus RTU master.

Additionally, the following settings apply:

- Baudrate: 19200
- Parity: Even
- Nr of start bits: 1
- Nr of stop bits: 1
- Nr of databits: 8
- Set the timeout parameter to approx. 150ms

Each fan has a default address that is structured as follows:

Communication Table

Variable	Register	Read/Write	Register type: Holding/Input
Set value (%)	D001	RW	H
Operating hours	D009	R	H
Current speed (rpm)	D010	R	I
Motor status	D011	R	I
Warning	D012	R	I
DC link voltage	D013	R	I

Variable	Register	Read/Write	Register type: Holding/Input
Power module temperature (°C)	D015	R	I
Motor temperature (°C)	D016	R	I
Electronics temperature (°C)	D017	R	I
Power (W)	D021	R	I
Device address	D100	RW	H
Set value source	D101	RW	H
Motor stop enable (P1)	D112	RW	H
Maximum speed (rpm)	D119	R	H
Ramp up time (s)	D11F	RW	H
Ramp down time (s)	D120	RW	H
Reference Uz	D1A0	R	H
Reference Iz	D1A1	R	H



Unless specified otherwise, parameters are encoded in 'big endian' format i.e. the byte with the highest-value bits come first.



Reading Holding registers: use Command 0X03 / Reading Input registers: use Command 0X04

Specific Parameter Info

Set Value

Address: D001

$$\text{Setvalue} [\%] = \frac{\text{Databytes}}{65536} \cdot \frac{nMax[rpm]}{780}$$

nMax [rpm] - see [D119] Maximum speed

Operating hours

Address: D009

$$\text{Operatingtime} [h] = \text{Databytes}$$

The maximum value that can be counted is 65535 hours (approx. 7.5 years) after which the counter is no longer incremented and stays at 65535.

Current Speed

Address: D010

$$\text{Actualspeed} [rpm] = \frac{\text{Databytes}}{64000} \cdot nMax [rpm]$$

nMax [rpm] - see [D119] Maximum speed



If the actual speed exceeds the value "1.02 * maximum speed", the display will be limited to the value "1.02 * maximum speed" (0xFFFF0)

Motor Status

Address: D011

The motor status specifies errors currently detected in the fan.

Encoding:

MSB	0	0	0	UzLow	0	RL_Cal	0	n_Limit
LSB	BLK	HLL	TFM	FB	SKF	TFE	0	PHA

If a bit is set, the error described below has been detected:

UzLow	DC-link undervoltage
RL_Cal	Rotor position sensor calibration error
n_Limit	Speed limit exceeded
BLK	Locked motor
HLL	Hall sensor error
TFM	Motor overheated
FB	Fan bad (general error, set for every error that occurs)
SKF	Communication error between master controller and slave controller
TFE	Power module overheated
PHA	Phase failure

Warning

Address: D012

A warning is a stage preliminary to an error message, i.e. the limit value for the error message has almost been reached. Encoding: A set bit makes the warning active:

MSB	LRF	UeHigh	0	UzHigh	0	OpenCir	n_Low	RL_Cal
LSB	Brake	UzLow	TEI_high	TM_high	TE_high	P_Limit	L_high	I_Limit

LRF	Shedding function active (see also shedding function)
UeHigh	Supply voltage high
UzHigh	DC-link voltage high
OpenCir.	Open circuit at analog input or PWM input for the set value (voltage at analog input < open circuit limit value, or signal at PWM input statistically high)
n_Low	Actual speed is lower than speed limit for running monitoring
RL_Cal	Calibration of rotor position sensor in progress
Brake	Brake operation: set if an external force drives the motor in opposite direction with high speed for a prolonged period
UzLow	DC-link voltage low
TEI_high	Electronics interior temperature high
TM_high	Motor temperature high
TE_high	Output stage temperature high
P_Limit	Power limitation activated
L_high	Line impedance too high (DC-link voltage unstable)
I_Limit	Current limitation activated



DC Link Voltage

Address: D013

$$UzV = \frac{Databyte}{256} \cdot ReferenceUzV$$

Reference Uz(V) at address (D1A0)

Power Module Temperature

Address: D015

$$T_{Modul} [^{\circ}C] = Databytes$$

Motor Temperature

Address: D016

$$T_{Motor} [^{\circ}C] = Databytes$$

Electronics Temperature

Address: D017

$$T_{EI} [^{\circ}C] = Databytes$$

Power

Address: D021

$$P [W] = \frac{Databytes}{65536} \cdot ReferenceUz [V] \cdot ReferenceIz [A]$$

$$ReferenceUz [mV] = Databytes \cdot 20mV$$

$$ReferenceIz [mA] = Databytes \cdot 2mA$$

ReferenceUz[mV] at address [D1A0]

Referencelz[mA] at address [D1A1]

Device Address

Address: D100

$$Fanaddress = Databytes(LSB)$$

Set Value Source

Address: D101

The parameter specifies the source from which the set value is taken:

Value	Motor Stop
0	Analogue input 0 tot 10V
1	RS485 (default set value to parameter D001)

Motor Stop enable (P1)

Address: D112

Value	Motor Stop
0	Motor runs continuously (even if set value = 0)
1	Motor stops if set value = 0

Maximum speed

Address: D119

$$\text{Maximum speed [rpm]} = \text{Databytes}$$

Ramp up time

Address: D11F

$$\text{Ramp time [s]} = \text{Databytes} \cdot 2,5s$$

Ramp down time

Address: D120

$$\text{Ramp time [s]} = \text{Databytes} \cdot 2,5s$$



15 kW PM Fan Motor Modbus Communication

COMMUNICATION PARAMETERS

Modbus Address	Description	Default Value
8000	Comm Mode	Modbus
8100	Baud Rate	19200
8101	Parity	Even
8102	Transmission Mode	RTU

PARAMETER SPECIFIC INFORMATION

All reserved values in below table are not allowed to be changed.

Modbus function code 3 can be used to read registers 0 - 11135.

Modbus function code 4 can be used to read registers 11136-1273.

Modbus Address	Description	Bits	Description	Read/Write	Description
10000	Control World	Bits		R/W	Bit Modbus Address
		0	1 = Forward Rotation (standard)		0
		1	1 = Reverse Operation		1
		2	1 = Operation		2
		3	RESERVED		-
		4	1 = Reset Fault Command		4
		5-15	RESERVED		5
10001	Speed Frequency Point	0-5000	0.01 hz/LSB - example 5000 * 0.1 Hz/LSB = 50.00 Hz	R/W	0-5000
10002	Actual Speed Frequency	0-5000	0.01 hz/LSB - example 5000 * 0.1 Hz/LSB = 50.00 Hz	R	Frequency feedback
11136	Status	Bits		R	Bit Address
		0	1 = Operation Signal, 0 = Without Operation Signal		18176
		1	1 = in Operation		18177
		2	1 = in zero speed		18178
		3	0 = Reverse Rotation, 1 = forward rotation (standard)		18179
		4	0 = Abnormal Power-on, 1 = normal power on		18180
		5-6	RESERVED		-

Modbus Address	Description	Bits	Description	Read/Write	
		7	1 = Fault Occurring		18183
		8-15	RESERVED		-
11137	Warning	Bits		R	Bit Address
		0	1 = Low frequency detection LF, frequency \leq detection frequency		18192
		1	1 = High frequency detection GF, frequency \geq detection frequency		18193
		2	1 = Equal frequency detection EF, given and feedback frequency in the detection frequency band		18194
		3	1 = speed arrival (target feed = 1000 rpm)		18195
		4	RESERVED		-
		5	1 = over-torque detected		18197
		6	1 = undervoltage detected		18198
		7	1= Bus voltage is greater than 85% of rated voltage		18199
		8	1 = more than 5% of rated current in operation and 10% of rated current upon stopping		18200
		9	1 = general fault prediction		18201
11139	Running Frequency	0-5000	0.01 Hz/LSB - example 5000 * 0.01 Hz/LSB = 50.00 Hz	R	0-5000
11163	Fault Word 1	Bits	If Bit is set, indicated error had occurred		Bit Address
		0	module overcurrent protection		18608
		1	AC-DC fault		18609
		2	radiator overheating		18610
		3	brake unit fault		18611
		4	RESERVED		-
		5	RESERVED		-
		6	speed deviation		18614
		7	bus overvoltage		18615
		8	bus undervoltage		18616
		9	output phase loss		18617
		10	motor low-speed overcurrent		18618
		11	RESERVED		-
		12	RESERVED		-
		13	RESERVED		-
		14	RESERVED		-



Modbus Address	Description	Bits	Description	Read/Write	
		15	motor phase sequence error		18623
11164	Fault Word 1	Bits	If Bit is set, indicated error had occurred	R	Bit Address
Bits		0	Overspeed in the same direction		18624
		1	Reverse overspeed		18625
		2	RESERVED		18626
		3	Encoder communication fault		18627
		4	abc overcurrent		-
		5	Brake detection fault		-
		6	Input overvoltage		18630
		7	RESERVED		18631
		8	RESERVED		18632
		9	Encoder not self-learning		18633
		10	Output overcurrent		18634
		11	SINCOS encoder fault		18635
		12	Input phase loss		-
		13	Overspeed protection		-
		14	Motor overcurrent at high-speed		-
		15	Ground protection		18639
11165	Fault Word 1	Bits	If Bit is set, indicated error had occurred	R	Bit Address
Bits		0	bit0 capacitor aging		18640
		1	External fault		18641
		2	RESERVED		18642
		3	RESERVED		18643
		4	current sensor fault		-
		5	short circuit of braking resistor		-
		6	excessive instantaneous current value		18646
		7	output contactor fault		18647
		8	band-type brake switch fault		18648
		9	IGBT short-circuit protection		18649
		10	communication fault		18650
		11	abnormal input power supply		18651
		12	software overcurrent (abc phase current overcurrent)		-
		13	software overcurrent (current effective value overcurrent)		-

Modbus Address	Description	Bits	Description	Read/Write	
		14	analog input abnormality		-
		15	temperature sampling disconnection		18655
11169	Feedback speed	-60000	Corresponds to -300hz-300hz, acts as feedback to speed setpoint	R	-60000
11172	Output Voltage		Effective value of output voltage to one decimal place	R	
11173	Output Current		Effective value of output current to two decimal places	R	
11174	Output Torque	-2000	-100.0%~100.0% rated current of inverter	R	-2000
11176	Bus Voltage		Bus voltage	R	
11181	Radiator Temp (Inverter)		Temperature reading	R	
11190	Total Output Power		Total output power	R	
11203	Running Hours		Total running hours (in hour units)	R	

About cold weather operation

BAC cooling equipment can be operated in sub freezing ambient conditions provided the proper measures are taken. Listed below are general guidelines which should be followed to minimize the possibility of freeze-up. As these guidelines may not include all aspects of the anticipated operation scheme, system designer and operator must thoroughly review the system, location of the equipment, controls and accessories to ensure reliable operation at all times.

Protection against sump water freezing

To prevent sump water from freezing, either sump heaters or a remote sump located in a heated indoor area must be installed. For a seasonal shut down during the cold weather period, it is recommended to drain the sump and pump.

Drainage of the sump and pump will also be needed if dry operation is anticipated, even if sump heaters are installed. These heaters will NOT prevent sump water from freezing during dry operation at sub freezing ambient conditions. Remote sump installations are best suited for a flexible switch from wet to dry operation, as the sump water is protected at all times. For dry operation applications, ensure that make-up water line is shut off and make-up valve completely drained.

Thermostats for electrical sump heaters for this equipment are set to maintain a sump water temperature of 4°C.



CAUTION

Switch off heaters when the sump is drained.

Capacity control

In addition to protecting the sump water, all exposed water piping, in particular make-up water lines should be heat traced and insulated.

It is necessary to prevent the recirculating water from approaching freezing conditions when the system is operating under load. The most « critical » situation occurs, if operation at subfreezing conditions coincides with light load conditions. The key to protecting the recirculating water is capacity control by adjustment of air flow to maintain the temperature of the recirculating water minimal above 10°C.

The desired method to match the cooling capacity to load and weather conditions is to adjust the air flow by reducing the fan speed of all fans in parallel. More frequent visual inspections are required to confirm the absence of ice formation and ensure reliable operation at all times.

It is not recommended to cycle the spray pump as a means of controlling the unit capacity.

Spray pumps should be switched off when the fan(s) are idle or operating below minimum fan speed for pump (see table "Operating Logic" below.) Operation with pump but without fan(s) does not provide cooling capacity of any significance but could lead to small droplets, escaping from the water capture system. For this reason this operation mode should be avoided.

The purpose of a low level cut out switch for pump protection is to protect the pump from running dry in case of make-up failure or extreme water loss. The status of the alarm can be checked prior to pump start-up, but should not be considered during the first minute after start-up, since activation of the pump can cause a water level drop, that might trigger the alarm. Normal make-up will stabilize the water level after a short period of time. In case the low level alarm signals, that there is no longer enough water in the cold water sump to guarantee a proper operation, the pump should be stopped (after a time delay of 60 seconds) and only manually restarted after it has been verified that the water in the sump is at or near the overflow level.

 In case the low level pump alarm is used to stop the pump, appropriate control logic should be incorporated to prevent hunting of the pump motor. Once the spray pump is stopped, the water in suspension will drain back to the tank and raise the water-level above the alarm level, which will reset the alarm immediately. A manual reset of the alarm after solving the root cause of the low level alarm is recommended. Frequent start/stop or hunting will damage the motor.

The high level alarm is located just under the overflow level and is meant to give a warning in case occur with the make up system during operation. During shut down of the pump, the alarm may be triggered. The switch can also be used to fill up the unit after shut down period before starting the pump.

Operating Logic

In order to prevent the need for de-icing, run the unit in dry mode (without spray water) as long as possible. When the actual condensing temperature gets near the summer design condensing temperature with the fans running at their maximum speed and dry operation is no longer suitable to provide the full heat rejection, the spray pump can be activated while the fan speed should be maintained between the minimum fan speed for pump and the maximum winter fan speed (see table). Frequent switching between wet and dry operation should be avoided. When multiple Polairis™ units are installed on the same refrigeration circuit, it is recommended to run all units dry until both the maximum fan speed and the summer design condensing temperature are reached. With a rising heat rejection requirement, the individual units should then be switched to wet operation one by one, blocking their fan speed at the minimum fan speed for pump (see table). When all units are running in wet mode, the fan speed can be further increased on all units simultaneously to the maximum winter fan speed (see table). For units expecting to operate for sustained periods in freezing weather, a vibration switch should be used in order to detect possible ice build-up as soon as possible.

When the unit is not working during winter conditions, the space heater function is activated as long as the motors are energized. This will keep the motors running at low speed (approx. 40 RPM).

Please refer to "Specific Functions" on page 15 for more details.

	Minimum fan speed for pump	Maximum winter fan speed
PLC3-0814E-XXX-XX	150 RPM	350 RPM
PLC3-0820E-XXX-XX	150 RPM	350 RPM

7

PLC3 MAINTENANCE PROCEDURE

Checks and adjustments

COLD WATER BASIN AND BASIN STRAINERS

The cold water basin should be inspected regularly. Any debris which may have accumulated in the basin or on the strainers should be removed.

Quarterly, or more often if necessary, the entire cold water basin should be drained, cleaned and flushed with fresh water to remove the silt and sediment which normally collects in the basin during operation.

When flushing the basin, the strainers should be left in place to prevent the sediment from re-entering the unit system. After the basin has been flushed, the strainers should be removed, cleaned, and replaced before refilling the basin with fresh water.



CAUTION

Do not use acid to clean the strainers.

Remote Basin

The water level in the basin of equipment designed for remote basin operation is a function of the circulating water flow rate, water outlet connection size, quantity and location, and outlet piping size and configuration. The remote basin unit is supplied without a water make-up assembly and the basin operating level during remote basin operation is not adjustable.

ELECTRIC LEVEL WATER CONTROL PACKAGE

The control/probe head is fully potted and sealed so there are no user serviceable electronic components. The only services that are required are:

1. Clean the stainless-steel electrodes periodically to prevent accumulations of scale, corrosion, sludge or biological growth, which could interfere with the electrical circuit.
2. The water level is maintained at the recommended operating level regardless of the system thermal load. Therefore, it is not recommended that the operating level be adjusted.
3. During the start-up of units equipped with the electric water level control package, by-pass the control unit in order to fill the unit to the overflow connection.

Model	Operating height (measured from pan bottom) (mm)
PLC3-0814E-XXX-XX	527
LEPLC3-0814E-XXX-XX	527
PLC3 -0820E-XXX-XX	527
LEPLC3 -0820E-XXX-XX	527

Cold water basin operating heights



The "x" represents the variable numbers in the model numbers.

To check the operating level, proceed as follows:

4. Shut off fan(s) but keep pump(s) running.



CAUTION

Make sure that the fans are locked out before entering the unit.

5. Measure height from sump bottom to water level and compare with face value from table.
6. Check valve for leakage and replace valve, if necessary.

BLOW DOWN

In case of a continuous blow down with a metering valve in the bleed line, ensure that the valve is unobstructed and that blow down water can drain freely. Measure the blow down flow rate by recording the time needed to fill a given volume.

For automatic blow down using conductivity control, ensure that the conductivity probe is clean and that the blow down solenoid valve is operational. Unless you have a specific adjustment procedure, your water treatment company should check and adjust set points.

SUMP HEATER PACKAGE

Sump heaters must only operate in the winter to prevent the sump water from freezing, when the water pump(s) and the fan(s) are shut off.

Under no circumstances should sump heaters operate at other times as they could potentially heat the water to temperature levels, which are favourable to bacteriological growth. Ensure every six months the heater thermostat is properly set and clean. Also ensure that control and safety devices, such as low level cut out switches, are operational, clean and properly incorporated into the control circuit.



CAUTION

Sump heaters can be hot.

ROTATION OF FAN(S) AND PUMP(S)

Fans must rotate without obstruction and both fans and pumps must rotate in the correct direction, which is indicated by arrows on the equipment. Do not start in opposite direction as indicated. Check proper functioning as follows:

1. Stop fan(s) and pump(s).



CAUTION

Make sure that the fans are locked out and at standstill before entering the unit.

2. Turn the fan by hand to ensure rotation without obstruction. Remove obstruction, if present.
3. Start the pump(s) and check for the proper rotation as indicated by the arrow on the pump cover. If rotation is wrong, stop pump and correct electrical wiring.



CAUTION

Ensure that everyone has left the unit before locking the access door.

4. Start the fan(s) and check for proper rotation as indicated by the arrow on the fan housing. If rotation is wrong stop fan(s) and contact BAC.



If the fan(s) and/or motor(s) are standing still, the shaft must rotate occasionally and a check by hand must be done to ensure they are not blocked during stand still. When blocked, the pump or fan has to be loosened before start up.

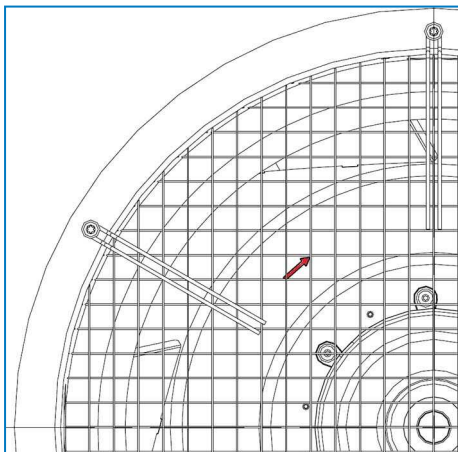

Fan rotation direction should be checked during commissioning, but also after every software update.

MOTOR VOLTAGE AND CURRENT

Check the voltage and the current of all three legs of the fan (at the terminal box outside the unit) and pump motors. The current should not exceed the nameplate rating.

When the motors are stored inside the unit, the motor insulation should be checked with a Megger insulation tester prior to restarting

1. Insulation resistance test – minimum value should be 1 Mega Ohm (1.000.000 Ohms). (not applicable for EC fan motors)
2. Thermistors, if fitted, should be checked for continuity with a multi-meter but never Megger-tested.
3. Ensure supply voltage and frequency correspond to the motor nameplate rating.
4. Ensure shaft turns freely.
5. Wire the pump motor in accordance with the wiring diagram as shown on the motor nameplate and/or in the motor terminal box. Fan motors are pre wired to a terminal box outside the unit.
6. Turn on unit and check amp draw does not exceed nameplate rating.



If motor is stored, it should be in a clean, dry place & have the shaft rotated occasionally. Storage areas should not be subject to vibration.



CAUTION

Rapid on-off cycling can cause the fan motor to overheat.

It is recommended that controls be set to allow a maximum of 6 on/off cycles per hour.

ELECTRICAL CONNECTIONS

Check and tighten electrical contacts if required before commissioning the unit. Transport may loosen some of the contacts, posing a risk for overheating or voltage drops. Also during operation, half-yearly checks are recommended.

UNUSUAL NOISE AND VIBRATIONS

Unusual noise and/or vibration are the result of malfunctioning of mechanical components or operational problems (e.g. unwanted ice formation). If this occurs, a thorough inspection of the entire unit followed by immediate corrective action is needed. If required, consult your local BAC representative for assistance.

Inspections and corrective actions

GENERAL CONDITION OF THE EQUIPMENT

The inspection should focus on following areas:

- damage of corrosion protection
- signs of scale formation or corrosion
- accumulation of dirt and debris
- presence of biofilms

Smaller damages of the corrosion protection **MUST** be repaired as soon as possible to prevent the damage from getting bigger. For Baltibond[®] hybrid coating use kit (part number 160550). Larger damages should be reported to the local BAC representative.

If there is evidence of scale formation (more than 0,1 mm) or corrosion, water treatment regime must be checked and adjusted by the supplier.

Any dirt and debris need to be removed following the "Cleaning Procedures" on page 1 .



If there is evidence of biofilms the system, including piping should be drained, flushed and cleaned of slimes and other organic contamination. Refill system with water and apply biocide shock treatment. Check pH value and functionality of ongoing biocide treatment.

It is highly recommended to frequently inspect the unit during extreme cold ambient conditions to check and remove any possible snow or ice accumulation.

HEAT TRANSFER SECTION

The inspection procedure is as follows:

1. Shut off fan(s) and pump(s).
2. Remove the eliminators and open access doors.
3. Inspect the coil for
 - obstructions
 - damages
 - corrosion
 - fouling
4. After inspection, install eliminators and close access doors and start pump(s) and fan(s).

Remove any obstructions from heat transfer section(s).

Any damages or corroded areas need to be repaired. Call your local BAC representative for assistance.

Minor fouling can usually be removed chemically or by temporary changes to the water treatment programme.

Contact your water treatment supplier for advice. Major fouling requires cleaning and flushing according to the "Cleaning Procedures" on page 1 .

Regular checking of the total aerobic bacteria count (TAB) and maintaining it within acceptable levels are the key to prevent fouling.

DRIFT ELIMINATORS

The inspection procedure is as follows:

1. With fan(s) and pump(s) running visually check for areas with excessive drift loss.
2. Shut off fan(s) and pump(s) and visually check eliminators for
 - obstructions
 - damages
 - cleanliness
 - proper fit
3. If any of the above problems have been observed, stop fan(s) and pump(s) and remove eliminators.
4. Clean eliminators from debris and foreign matter. Remove dirt and obstructions. Replace damaged or ineffective eliminators.
5. Install eliminators and ensure they fit tightly with no gaps.



CAUTION

Do not step on eliminators.

WATER DISTRIBUTION

The inspection procedure is as follows:

1. Shut off the fan(s), but leave the pump(s) running.
2. Check and adjust spray pressure, if required.
3. Remove the eliminators.
4. Check to see if the nozzles are producing the spray pattern shown in figure(s) below

5. Shut off pump(s) and clean water distribution from dirt and debris. Ensure spray branches and nozzles are in place and clean. Replace damaged or missing nozzles.
6. Install eliminators and ensure they fit tightly with no gaps.
7. Start fan(s) and pump(s).

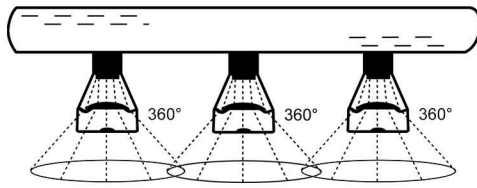

Nozzle spray distribution type

WATER COLLECTION

The inspection procedure is as follows:

1. Shut off fan(s) and pump(s).



CAUTION

Make sure that the fans are locked out and at a standstill before entering the unit.

2. Remove the knobs out of the water wall panels and remove these two panels. This allows for inspection of this area.
3. Visually inspect the water wall and sump for:
 - obstructions
 - damages
 - corrosion
 - fouling
4. Remove any obstructions.
5. Re-install the two panels of the water wall.
6. Remove the removable section of the water collection channels.
7. Remove any obstructions and clean the water collection channels.
8. Re-install all water collection channels in the same way they are removed.
9. Re-install the top panels of the water guiding wall.



CAUTION

Ensure that everyone has left the unit before locking the access doors.

10. Start the fan(s) and pump(s).



FAN AND MOTOR

During operation it is required to clean the outside surface of the motor and fan at least every 6 months (or more often depending on site conditions) to ensure proper motor cooling and avoid fan wheel imbalance. On a quarterly or six monthly basis check:

- Electric connections
- Motor protection devices
- Check amp draw
- Motor bearings for noise/overheating
- External surface of motor and fan for corrosion or deposits.
- Fan for damage to blades and housing
- Motor condensation holes for clogging, where necessary

When cleaning the outside surface of the motor and fan:

- Do not use a water jet or high-pressure cleaner
- Do not use any acid, alkali or solvent-based cleaning agents
- Do not use any pointed or sharp-edged objects for cleaning



CAUTION

Make sure no weight clips are removed during cleaning.



CAUTION

Make sure only 1 fan at the same time is replaced for structural safety.

SPRAY WATER PUMP

The BAC pump contains a mechanical seal between pump housing and pump motor. This seal needs to be checked quarterly for proper operation and replaced if necessary.

The warranty coverage for pump seals is subject to certain limitations. Damages, primarily attributed to issues such as sticky seals, dry running, chemical attacks, and pollution by solids, fall outside the scope of our comprehensive warranty.

In the event of seal malfunction within the warranty period, a replacement seal will be provided. However it is essential to note that the warranty does not include the labour to replace the defective parts.

To prevent seal damage, pumps should be filled with water prior to starting and one must make sure the pump is loose by hand to avoid rupture which can occur due to sticky seal after a longer period of standstill.

Start-up

- Fill the cold water basin with fresh water to the overflow level via the make-up valve.
- Set the make-up valve float so the water shuts off at the overflow level.
- Start the spray pump.
- Open the valve in the unit bleed line.
- Start the fan motors.
- Adjust the bleed by closing or opening the bleed valve.
- Once the unit is operating, check the current and voltage of the fan motors with a heat load on the unit under warm ambient conditions. The current must not exceed the nameplate ratings.
- Check the operation of the optional vibration cutout switch.

After 24 hours of operation under thermal load, perform the following services:

- Check the unit for any unusual noise or vibrations.
- Check the operating water level in the cold water basin.
- Adjust make-up valve if necessary.
- Check the belt tension and readjust if necessary.

Cleaning procedures

MECHANICAL CLEANING

Keeping your evaporative cooling equipment (and the associated system) clean will maintain its efficiency and help to prevent uncontrolled bacteriological growth. The recommended cleaning procedures are described below:

1. Disconnect fan and pump motor(s) and shut off make-up supply.
2. Remove fan screens, eliminators and drain system. Do not remove sump strainer.
3. Clean debris from exterior, fan motor(s) and fan(s) with soft brush, if necessary use water and soap.
4. Clean interior with (soap) water and soft brush, if necessary use high pressure water jet.
5. Remove any debris from water distribution system and clean any nozzles if clogged. If necessary nozzle and grommet may be removed for cleaning.
6. Remove debris from heat transfer section (coil) and water collection channels.
7. Flush with clean water and drain to remove accumulated dirt.
8. Remove, clean and replace sump strainer(s).
9. Clean debris from fan screens and eliminators with water jet and install.
10. Remove debris from access doors and panels with soft brush and (soap) water.
11. Close drain and open make-up supply. Fill system up to overflow level with clean water.



DISINFECTION

Disinfection of your cooling system may be needed in case of high concentration of aerobic bacteria and/or Legionella. Disinfection is also recommended for evaporative cooling systems with known or suspected high bacteriological levels, prior to a cleaning procedure.

Some local or national guidance also recommends disinfection prior to initial start up, after a prolonged shut down, after routine cleaning operations or when significant alterations have been made to the cooling system. Disinfection must be carried out in accordance with a proper procedure and take into account the safety of the cleaning and disinfection staff.

Typically disinfection is achieved using a sodium hyper chloride solution to maintain a residual value of 5 - 15 mg/l of free chlorine and circulate this around the system for up to 6 hours. Higher chlorine levels for a shorter period are possible, but require a higher level of corrosion protection than galvanized steel only. Consult your BAC representative for further information.

Excessive levels of chlorine must be avoided as this quickly can lead to corrosion and damage to your system. Chlorinated water should be de-chlorinated before draining and after disinfection the system must be thoroughly flushed through with clean water.



A proper regularly monitored biocide programme reduces the need for cleaning and disinfection actions significantly.



About comprehensive maintenance

In order to ensure maximum efficiency and minimum downtime of your evaporative cooling system, it is recommended to establish and execute a programme of preventive maintenance.

Your local BAC representative will assist you in establishing and implementing such programme. The preventive maintenance programme must not only avoid that excessive downtime occurs under unforeseen and unwanted conditions, it also ensures that factory authorized replacement parts are used, which are designed to fit and for their purpose carry the full factory warranty. To order factory authorized parts, contact your local BAC representative. Make sure you include the unit serial number when ordering any parts.

To facilitate servicing of the equipment, it is suggested that the following parts be carried on hand:

- Make-up float ball (if applicable)
- Water make-up valve
- Spray nozzles and grommets
- Spray distribution branch grommets
- Baltibond® repair (touch-up) kits

Insist on factory authorised parts to avoid loss of efficiency or an operational risk, which may occur when non authorised parts are used.

Prolonged outdoor stay

Should the unit(s) be stored outside for approximately one month (shelf life) or longer, or stored in severe climates, it is imperative that certain actions be performed by the installing contractor in order to maintain the unit in "as shipped" condition. These actions include but are not limited to:

- Rotate the fan(s) once per month, at least 10 revolutions. The motors are equipped with a space heater function that will keep the motors running at low speed (approx. 40RPM) as long as the motors are energized. Refer to chapter 4: "Fan motor Communication - Specific functions" for more details.
- Rotate the pump motor shaft once per month, at least 10 revolutions.
- Add desiccants to control panel interiors.
- Wrap motor in non-plastic protective material.
- Keep drains open on the cold water basins.
- Ensure unit(s) is stored on level ground surface.
- Protect all black steel components with RUST VETO or equivalent corrosion protective material.

For complete instructions, please contact your local BAC representative.

The service expert for BAC equipment

We offer tailored services and solution for BAC cooling towers and equipment.

- Original spare parts and fill -for an efficient, safe and year round reliable operation.
- Service solutions - preventive maintenance, repairs, refurbishments, cleaning and disinfection for reliable trouble-free operation.
- Upgrades and new technologies - save up energy and improve maintenance by upgrading your system.
- Water treatment solutions - equipment for controlling corrosion scaling and proliferation of bacteria.

For more details, contact your local BAC representative for further information and specific assistance at www.BACservice.eu

More information

REFERENCE LITERATURE

- Eurovent 9-5 (6) Recommended Code of Practice to keep your Cooling System efficient and safe. Eurovent/Cecomaf, 2002, 30p.
- Guide des Bonnes Pratiques, Legionella et Tours Aéroréfrigérantes. Ministères de l'Emploi et de la Solidarité, Ministère de l'Economie des Finances et de l'Industrie, Ministère de l'Environnement, Juin 2001, 54p.
- Voorkom Legionellose. Ministerie van de Vlaamse Gemeenschap. December 2002, 77p.
- Legionnaires' Disease. The Control of Legionella Bacteria in Water Systems. Health & Safety Commission. 2000, 62p.
- Hygienische Anforderungen an raumluftechnische Anlagen. VDI 6022.

INTERESTING WEBSITES

Baltimore Aircoil Company	www.BaltimoreAircoil.com
BAC Service website	www.BACservice.eu
Eurovent	www.eurovent-certification.com
European Working Group on Legionella Infections (EWGLI)	EWGLI
ASHRAE	www.ashrae.org
Uniclîma	www.uniclîma.fr
Association des Ingénieurs et techniciens en Climatique, Ventilation et Froid	www.aicvf.org
Health and Safety Executive	www.hse.gov.uk

ORIGINAL DOCUMENTATION



This manual is originally made in English. Translations are provided for your convenience. In the event of discrepancies, the English original text shall prevail over the translation.



A series of horizontal dotted lines for writing, spanning the width of the page.



A series of horizontal dotted lines spanning the width of the page, providing a template for writing or data entry.





A series of horizontal dotted lines for writing, spanning the width of the page.

COOLING TOWERS

CLOSED CIRCUIT COOLING TOWERS

ICE THERMAL STORAGE

EVAPORATIVE CONDENSERS

HYBRID PRODUCTS

PARTS, EQUIPMENTS & SERVICES

BLUE by nature
GREEN at heart



www.BaltimoreAircoil.com

Europe@BaltimoreAircoil.com

Please refer to our website for local contact details.

Industriepark - Zone A, B-2220 Heist-op-den-Berg, Belgium

© Baltimore Aircoil International nv



**BALTIMORE
AIRCOIL COMPANY**



RGOMALL-06 Universal Electric Water Level Control For part number 313555

INSTALLATION, OPERATING & MAINTENANCE

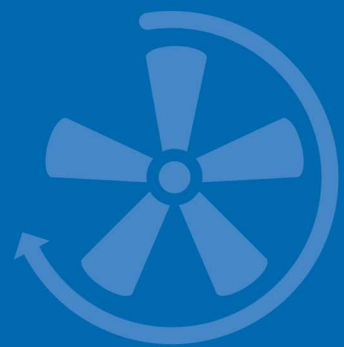
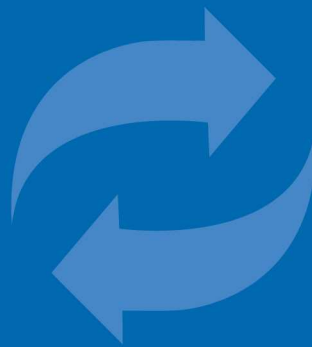



Table of contents

INSTALLATION, OPERATING & MAINTENANCE INSTRUCTIONS



2	Introduction	4
	Introduction	4
3	Installation	5
	Installation	5
4	Operation	9
	Sequence Of Operation	9
	LED Error Indicator Lights	12
	LED indicator lights	13
	Operation and Maintenance	13
	EWLC specifications	13
	Wiring EWLC	14
5	Further Assistance & Information	15
	The service expert for BAC equipment	15
	More information	15

Introduction

BAC-EWLC-6P (BAC part number 313555) is a 6-probe electronic water level controller (EWLC). This EWLC is a conductivity actuated, probe type liquid level controller that is used for:

- maintaining proper operation water level when connected to a normally closed solenoid valve in evaporative heat rejection equipment
- outputting alarm and shutdown signal for present water levels

This EWLC provides vital water level sensing and control functions as per BAC control parameters. It provides 4 status LEDs along with 3 error LEDs to provide clear indications of operational status and level related errors, along with quality of water for proper operation of entire system. See below for the different components.

EWLC COMPONENTS

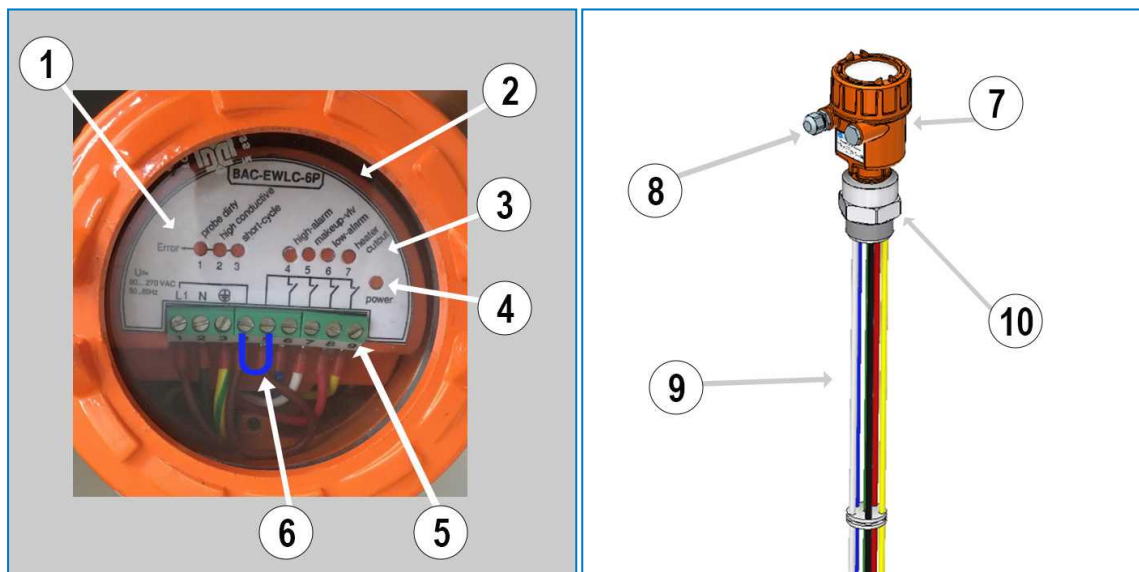

1. 3 error
2. Transparent cover
3. 4 status LED's
4. Power LED
5. Connection terminals
6. Bridge (operation without PLC)
7. IP-68 pressure die-cast aluminium enclosure
8. PG11 cable glands
9. SST probes with PVC coating
10. 2" MPT PVC connection

3

RGOMALL-06 INSTALLATION

Installation

On new equipment the EWLC will ship installed as show in the typical installation below.

TYPICAL INSTALLATION

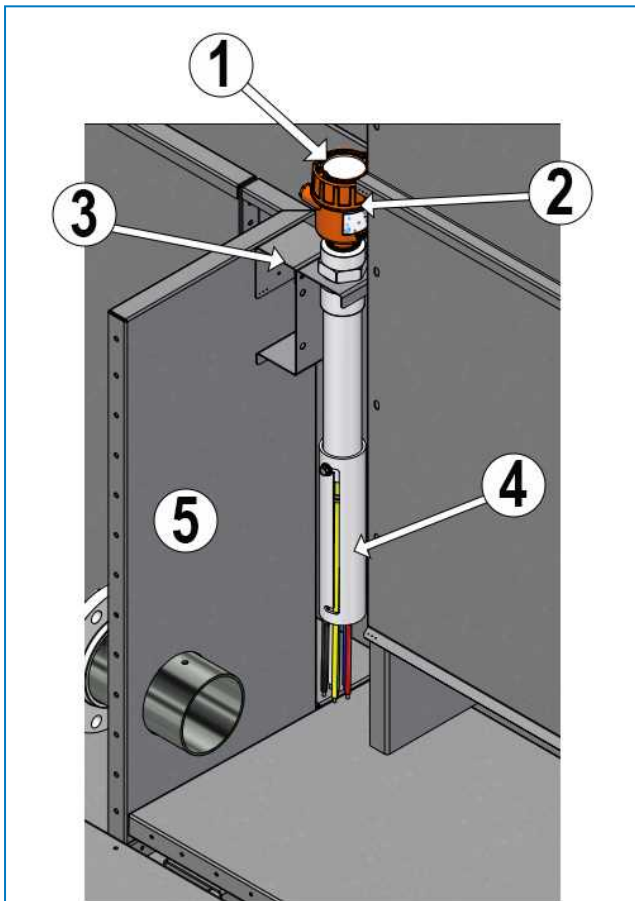

1. Status code LED
2. EWLC control
3. Support EWLC
4. PVC stilling chamber
5. Water basin



The probe lengths are pre-cut from factory.



ELECTRICAL CONNECTIONS

The EWLC will have a cable 1800 mm long and UV resistant. This cable needs to be connected with the proper wire connections as mentioned below.

Wire color	Description
Brown	Power supply hot
Black	Power supply neutral
Green/Yellow	Ground
Blue	High alarm
White	Make up valve
Red	Low alarm
Yellow	Heater cut-out



CAUTION

Please put watertight wire nut(s) on end of wires that are not used.

The Build in Management system (BMS) controlled the different states of all the contacts in the EWLC. In the picture below the initial positions can be found during operation (mentioned that contact 7 & 8 are normally closed without water contact).

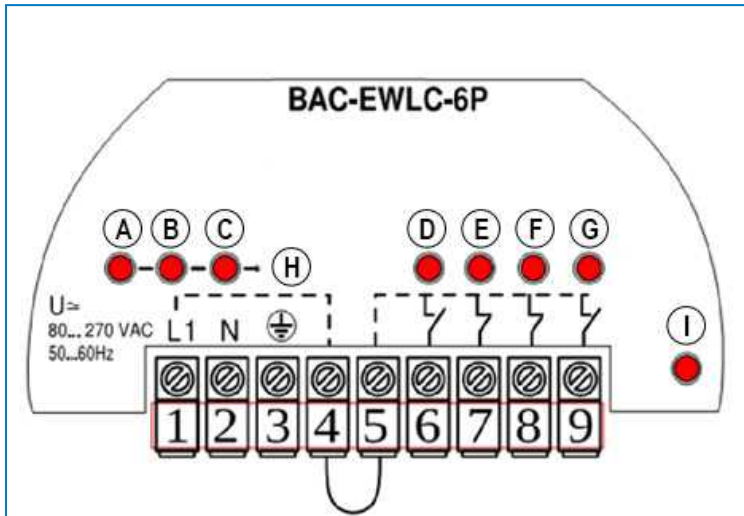

- a) Probe dirty
- b) High conductive
- c) Short-cycle
- d) high-alarm
- e) make-up valve
- f) low-alarm
- g) heater cut-out
- h) error
- i) power



The total setup of all the electrical components can be found in the submittal package.

FILL AND START-UP

Before start-up the unit must be filled by hand until the water level is 1 cm below the overflow connection.

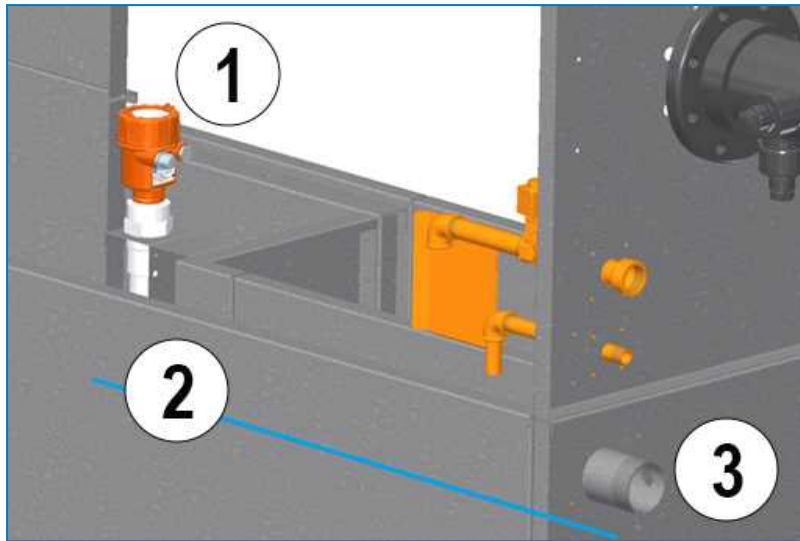

1. Electric Water Level Control
2. Water level
3. Overflow connection

Then the system can be energized. After this check the unit periodically during the first few hours to ensure that the control is working properly and that the water level is set up correctly.

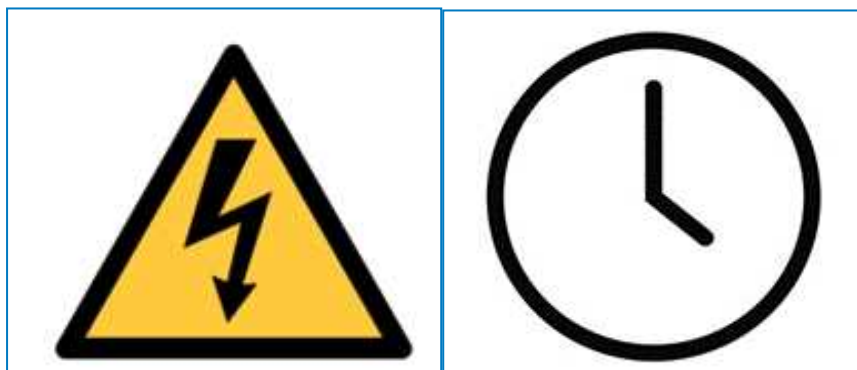

Check during start-up

4

RGOMALL-06 OPERATION

Sequence Of Operation

The following information explains EWLC operation with respect to water level.

Legend: Water Level at Probe

1. Blue
2. Black
3. White/Clear
4. Red
5. Yellow
6. Green

	Water level at probe	Terminals	LED	LED / Alarm name	Explanation
Water level rising				High alarm OFF Make-up valve ON Low alarm ON Heater Cut-out ON	When water level is lower than yellow probe. Heater is cut out due to low level of water.
Water level rising				High alarm OFF Make-up valve ON Low alarm ON Heater Cut-out OFF	When water fills up to yellow probe, terminal 9 shorts from terminal 5. Heater can now be turned ON as water level is sufficient for the heater to operate.

	Water level at probe	Terminals	LED	LED / Alarm name	Explanation
Water level rising				High alarm OFF Make-up valve ON Low alarm OFF Heater Cut-out OFF	When water fills up to white/clear probe, no change is made as this level is lower level for make-up valve ON/OFF operation.
Water level rising				High alarm OFF Make-up valve OFF Low alarm OFF Heater Cut-out OFF	When water fills up to black probe, terminal 7 opens from terminal 5.
Water level falling				High alarm OFF Make-up valve OFF Low alarm OFF Heater Cut-out OFF	If water falls lower than black probe, but not below white/clear probe, terminal 7 stays open from terminal 5.

	Water level at probe	Terminals	LED	LED / Alarm name	Explanation
Water level falling				High alarm OFF Make-up valve ON Low alarm OFF Heater Cut-out OFF	If water level falls lower than white/clear probe, terminal 7 shorts to terminal 5 to turn make-up valve ON.
Water level rising				High alarm OFF Make-up valve OFF Low alarm OFF Heater Cut-out OFF	When water fills up to black probe, terminal 7 opens from terminal 5, turning make-up valve OFF.
Water level rising				High alarm ON Make-up valve OFF Low alarm OFF Heater Cut-out OFF	When water fills up to blue probe, terminal 6 shorts to terminal 5, to give high alarm.

LED Error Indicator Lights

Probe condition	Description	LED
	<p>Water level is sensed at black probe but not at white/clear probe. White/clear probe should be dipped when level is back up to black probe.</p>	<p>Short-cycle</p> <p>Short-cycle LED will stay OFF otherwise.</p>
	<p>Sensing probe dipped in high conductivity water, indicating presence of minerals that may lead to rusting.</p>	<p>High conductivity</p> <p>High conductivity LED will stay OFF otherwise.</p>
	<p>At least two level probes dipped in water having low conductivity, indicating presence of organic growth around probes or dirty probes.</p>	<p>Probe dirty</p> <p>Probe dirty LED will stay OFF otherwise.</p>

Legend: Water Level at Probe

1. Blue
2. Black
3. White/Clear
4. Red
5. Yellow
6. Green

LED indicator lights

Light Mark	Function if light on
Power	Power supplied
Probe dirty	Notify probe needs to be cleaned
High conductive	Water conductivity is too high, notify high saline water
Short-cycle	Short circuit between probes
High-alarm	Water level is too high
Make-up valve	Make-up valve is on
Low-alarm	Water level is too low
Heater-Cut-out	Water level is higher than header

LED indicator light function

Operation and Maintenance

The control/probe head is fully potted and sealed so there are no user serviceable electronic components. The only services that are required are:

- Clean the stainless-steel electrodes periodically to prevent accumulations of scale, corrosion, sludge or biological growth, which could interfere with the electrical circuit.
- The water level is maintained at the recommended level regardless of the system thermal load. Therefore, it is not recommended that the operating level be adjusted.
- During the start-up of units equipped with the electric water level control package, by-pass the control unit in order to fill the unit to the overflow connection.

EWLC specifications

BAC part number	313555
Input power	80 - 270VAC, 50/60 Hz
Enclosure type	IP68
Operational ambient temperature range	-28°C - 40°C
Time delay	6 seconds

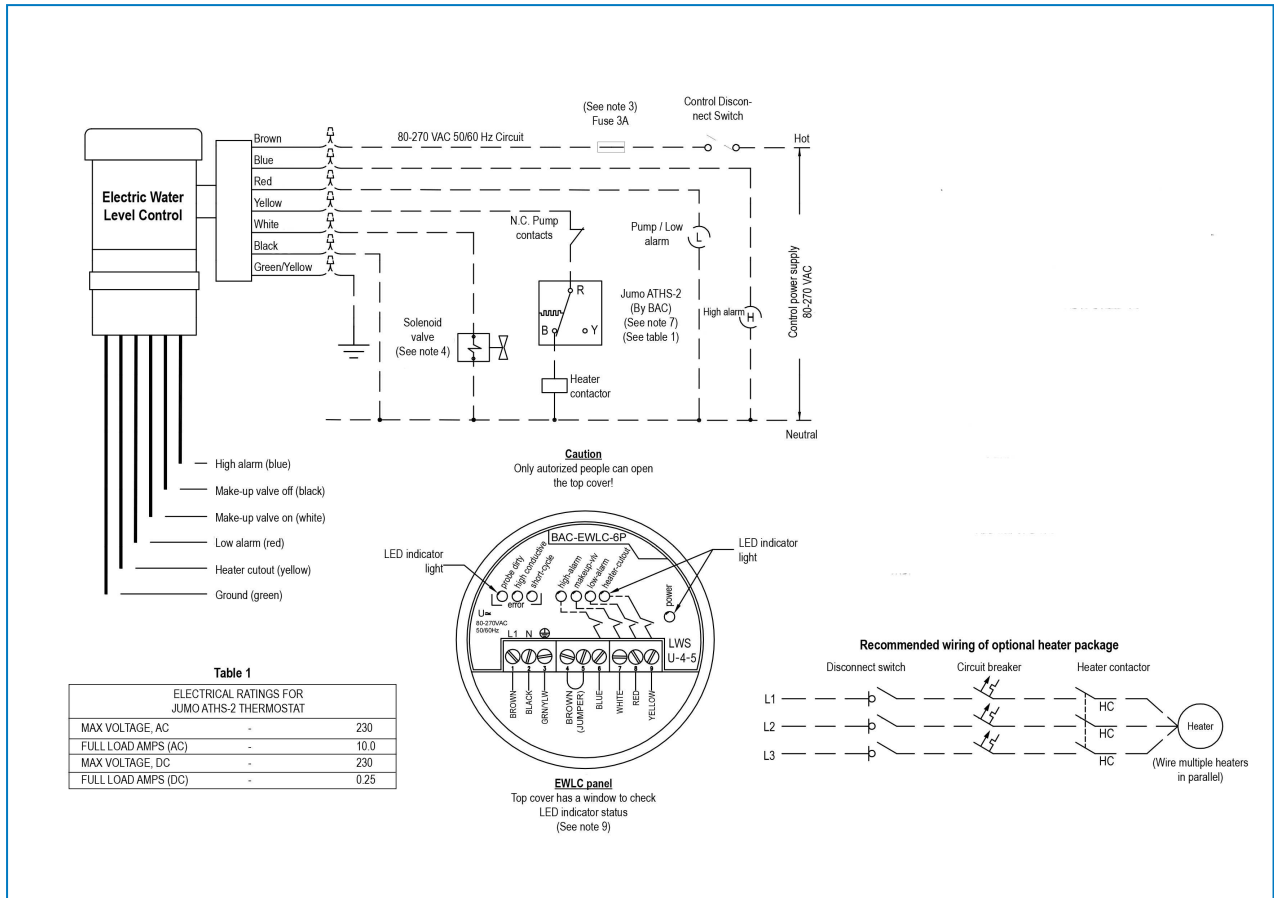

Notes

1. Wiring and components indicated by dashed lines are to be supplied by firms other than BAC. All wiring must comply with applicable codes and ordinances.
2. The water level control board is wired in the inverse mode so that the solenoid make-up valve will close if there is a loss of power to the control board. When the water level rises to the bottom of the make-up valve off probe and maintains contact for at least 6 seconds, the control de-energizes the valve. The valve remains de-energized until the water level recedes below the bottom of the make-up valve on probe and remains at that level for at least 6 seconds. The control then energizes the valve.
3. Any incoming power must have a 3A fuse for component protection, using a fuse over 3A will void BAC warranty.
4. The solenoid actuated make-up valve is rated at 10 Watts, 230 VAC, 50 Hz.
5. The normally closed solenoid valve has a slow closing feature which minimizes water hammer and is designed to operate at make-up water line pressures of 0.3 to 10 bar. To further minimize the potential of water hammer, make-up water line pressures at the higher end of the range should be avoided, and make-up piping should be well supported.
6. Interlock immersion heaters with circulating pump to de-energize heaters when pump is running.
7. Control thermostat is to be set for 4°C. Do not set thermostat lower than 4°C.
8. A strainer is required before the solenoid make-up valve.
9. LED indicator light is on when a function is active or error is found.
10. Solenoid valve, heater and heater thermostat are optional and may not be present on the unit.



The service expert for BAC equipment

We offer tailored services and solution for BAC cooling towers and equipment.

- Original spare parts and fill -for an efficient, safe and year round reliable operation.
- Service solutions - preventive maintenance, repairs, refurbishments, cleaning and disinfection for reliable trouble-free operation.
- Upgrades and new technologies - save up energy and improve maintenance by upgrading your system.
- Water treatment solutions - equipment for controlling corrosion scaling and proliferation of bacteria.

For more details, contact your local BAC representative for further information and specific assistance at www.BACservice.eu

More information

REFERENCE LITERATURE

- Eurovent 9-5 (6) Recommended Code of Practice to keep your Cooling System efficient and safe. Eurovent/Cecomaf, 2002, 30p.
- Guide des Bonnes Pratiques, Legionella et Tours Aéroréfrigérantes. Ministères de l'Emploi et de la Solidarité, Ministère de l'Economie des Finances et de l'Industrie, Ministère de l'Environnement, Juin 2001, 54p.
- Voorkom Legionellose. Minsterie van de Vlaamse Gemeenschap. December 2002, 77p.
- Legionnaires' Disease. The Control of Legionella Bacteria in Water Systems. Health & Safety Commission. 2000, 62p.
- Hygienische Anforderungen an raumluftechnische Anlagen. VDI 6022.

INTERESTING WEBSITES

Baltimore Aircoil Company	www.BaltimoreAircoil.com
BAC Service website	www.BACservice.eu
Eurovent	www.eurovent-certification.com
European Working Group on Legionella Infections (EWGLI)	EWGLI
ASHRAE	www.ashrae.org
Uniclma	www.uniclma.fr
Association des Ingénieurs et techniciens en Climatique, Ventilation et Froid	www.aicvf.org
Health and Safety Executive	www.hse.gov.uk

ORIGINAL DOCUMENTATION



This manual is originally made in English. Translations are provided for your convenience. In the event of discrepancies, the English original text shall prevail over the translation.





A series of horizontal dotted lines for writing, spanning the width of the page.



A series of horizontal dotted lines spanning the width of the page, providing a template for handwritten notes or a list.





A series of horizontal dotted lines for writing, spanning the width of the page.

COOLING TOWERS

CLOSED CIRCUIT COOLING TOWERS

ICE THERMAL STORAGE

EVAPORATIVE CONDENSERS

HYBRID PRODUCTS

PARTS, EQUIPMENTS & SERVICES

BLUE by nature
GREEN at heart



www.BaltimoreAircoil.com

Europe@BaltimoreAircoil.com

Please refer to our website for local contact details.

Industriepark - Zone A, B-2220 Heist-op-den-Berg, Belgium

© Baltimore Aircoil International nv