







VTL-E >>> Retrofit Opportunities



-  Improve maintenance and accessibility
-  Enhance operational safety
-  Reduce sound emission
-  Save water
-  Save energy and increase performance
-  Increase reliability



High temperature execution



Steel drift eliminators



Oversized motor & Drive set



Discharge hood



High level access platform



Clean out port



BCP automatic bleed control



Separator



Basin sweeper piping



Plume abatament coil



Intake & discharge attenuation



Baltiguard (standby motor & motor base)

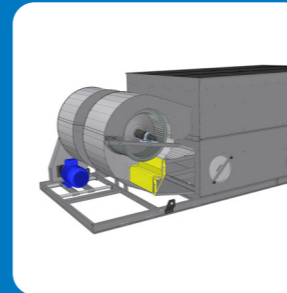

Backdraft dampers



Heater package



Electric water level control package

Note: The drawings on this page are for reference only, and may vary from the actual solution offered.