



**BALTIMORE  
AIRCOIL COMPANY**



## **TVC Adiabatic Condenser Once Through Mode**

### **SOFTWARE INSTRUCTIONS**

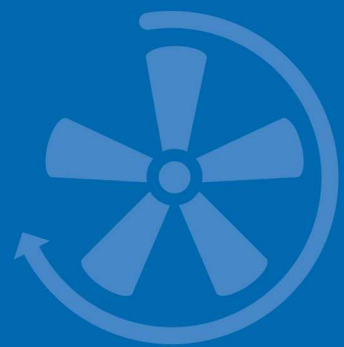
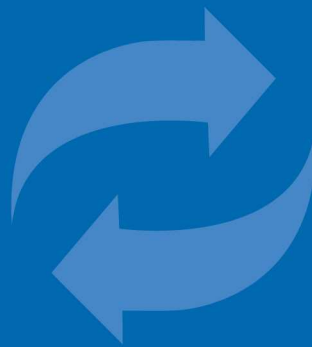



# Table of contents

## SOFTWARE INSTRUCTIONS

|          |   |           |
|----------|---|-----------|
| <b>1</b> | <b>Scope</b>  | <b>3</b>  |
|          | Once Through execution                                    | 3         |
| <b>2</b> | <b>Control Logic</b>                                      | <b>4</b>  |
| <b>3</b> | <b>Programmable logic controller</b>                      | <b>6</b>  |
|          | Programmable Logic Controller (PLC)                       | 6         |
|          | Display and operations                                    | 6         |
| <b>4</b> | <b>Software</b>   | <b>8</b>  |
|          | Menu overview   | 8         |
|          | Main Loop Menu (P)  | 9         |
|          | User Menu (E)   | 10        |
|          | Working Time Menu (T)                                     | 15        |
|          | Inputs Outputs Menu (I)                                   | 16        |
|          | Clock Menu (K)  | 17        |
|          | Logger Menu (H)   | 17        |
|          | System Information (S)                                    | 18        |
|          | Maintenance Menu (M)                                      | 18        |
| <b>5</b> | <b>Alarms and Warnings overview</b>                       | <b>20</b> |
|          | Alarms overview   | 20        |
| <b>6</b> | <b>BMS Communication</b>                                  | <b>22</b> |
|          | Available communication protocols and communication cards | 22        |
|          | Communication table for Modbus RS485                      | 23        |
| <b>7</b> | <b>Further Assistance &amp; Information</b>               | <b>26</b> |
|          | More information  | 26        |
|          | The service expert for BAC equipment                      | 26        |

This manual applies to units configured in Once-Through mode operating on BAC software version V2.0.15 or later, in stand-alone mode.

## Once Through execution

The TVC is a V-shaped dry condenser equipped with **adiabatic pre-coolers (1)** that cool the warm **process fluid (2)** by sensible heat transfer. **Water flows (3)** evenly over evaporative cooling pads located in front of the **dry finned coil (4)**. At the same time **axial (5) fans** draw **air (6)** through the pads where a portion of the water evaporates and cools down the saturated air. This increases the cooling capacity of the incoming air for cooling the process **fluid (7)** inside the coil.

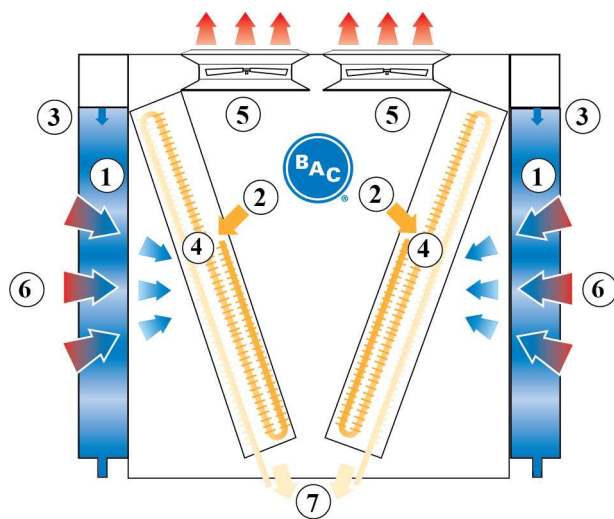

## CONTROL LOGIC

The controller controls the fan speed based on the actual fluid outlet temperature and the standard or free-cooling setpoint, ensuring a minimum electrical consumption and noise level. The controller will activate and deactivate the adiabatic pre-coolers, one by one, based on a logical combination of fan speed and two ambient temperature switchpoints.

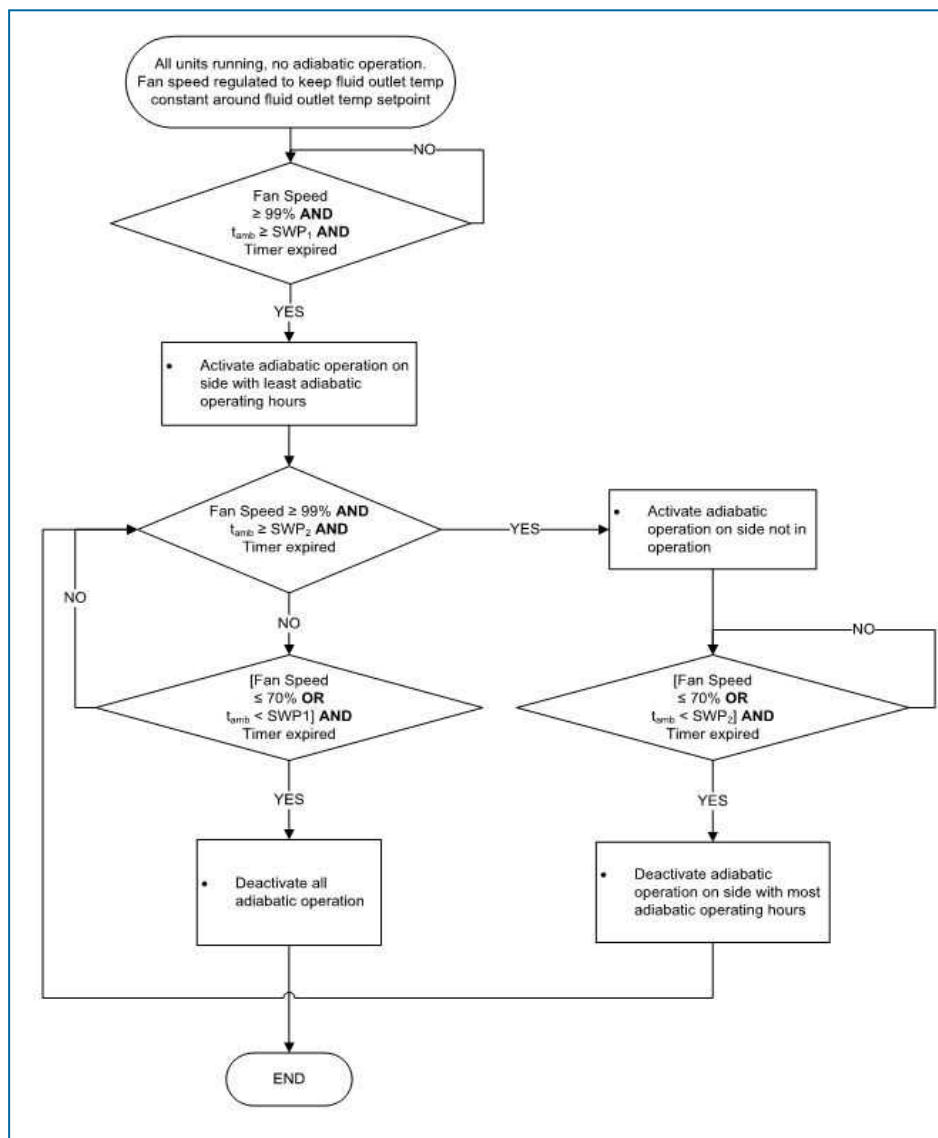

$t_{amb}$ : ambient temperature  
 SWP1, SWP2: ambient temperature switchpoints  
 CWV: adiabatic pre-cooler city water valve  
 DV: adiabatic pre-cooler drain valve

The standard setpoint, the free-cooling setpoint and the two ambient temperature setpoints are adjustable via the User menu. The controller continuously measures the fluid outlet temperature via a temperature sensor installed in the fluid out pipe and the ambient temperature via a temperature sensor that is factory installed on the unit.

The controller is pre-programmed and ready for operation. However, depending on the size of the installation, you may need to adjust the pre-programmed parameters during start-up.



**CAUTION**

**Changing the controller's parameters may result in an undesired operation of the unit such as a hunting phenomenon, premature activation of pre-cooling (hence increased water consumption) or in late pre-cooling activation resulting in fluid outlet temperatures exceeding the design temperature.**

# 3 PROGRAMMABLE LOGIC CONTROLLER

## Programmable Logic Controller (PLC)

The PLC with built-in display:







## Display and operations

The controller display contains the screen and six operation keys.

The screen allows eight lines of text. The screen title and the screen reference are always on the top line.

Use the operation keys to navigate between the different menus and screens.

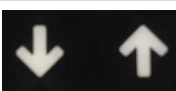
|   |                  |                               |
|---|------------------|-------------------------------|
|  | <b>Alarm key</b> | Display the alarm menu.       |
|  | <b>Menu key</b>  | Display the main menu screen. |

|   |                   |  |
|---|-------------------|--|
|  | <b>Back key</b>   | Revert to the previous step or menu.                                     |
|  | <b>Arrow keys</b> | Navigate between the different screens and menus.                        |
|  | <b>Enter key</b>  | Select the marked menu or parameter or enable the change of a parameter. |



## Menu overview

| Menu            | Screen reference | Function  |
|-----------------|------------------|---|
| Main loop       | P                | Readout: <ul style="list-style-type: none"><li>- The unit status (ON/OFF)</li><li>- The condenser pressure and ambient temperature</li><li>- The fan speed</li><li>- The pre-cooler status</li></ul>  |
| User            | E                | Set: <ul style="list-style-type: none"><li>- Run authorisation / local ON/OFF</li><li>- Standard and free-cooling set-point</li><li>- PI parameters</li><li>- Ambient temperature switch point for Adiabatic pre-cooling</li><li>- Adiabatic pre-cooler delay</li><li>- Adiabatic pre-cooler cleaning cycle</li><li>- Night quiet mode</li><li>- Time delay on alarm messages</li><li>- BMS communication settings</li></ul> The standard password for the User Menu is "1234". |
| Manufacturer    | C                | This menu is password protected and is not accessible to unauthorized personnel.  |
| Working time    | T                | Readout the operating hours for the fans and adiabatic pre-cooling.   |
| Inputs/outputs: | I                | Readout the input and output status.  |
| Clock           | K                | Set the correct time and date.  |
| Logger          | H                | Readout the alarm and warning history.  |
| System info     | S                | Readout the software and bios version.  |
| Maintenance     | M                | Set the inputs and outputs manually for test purposes.<br>The standard password for the Maintenance menu is "9876".   |



# Main Loop Menu (P)



The screens in the Main Loop Menu are read-only and cannot be edited.

## Screen P01

```

10:50 23/11/18 P01
BACH1800000 01 Ad:1
Setpoint 06.0bar
Pout 03.1bar
Tamb 33.1°C
Fan speed 000.0%
On
  
```

Main screen with general information:

- The current time and date.
- The unit serial number and pLAN address: “**Ad: 0**”.
- “**Setpoint**”: the active setpoint for the condenser pressure.
- “**Pout**”: the measured condenser pressure.
- “**Tamb**”: the measured ambient temperature.
- “**Fan speed**”: the current fan speed.
- The unit status: “**ON**” or “**OFF**”.

### Note

*Unit status ON implies that the unit is ready to automatically respond to any heat rejection requirement, even in case the fans are temporarily deactivated due to the absence of a heat load.*

## Screen P03

```

Inputs P03
Pout 003.1bar
Tamb 033.1°C
Control signal 000.0%
Local En/Dis ON
BUS En/Dis ON
  
```

Overview of all inputs:

- “**Pout**”: the measured condenser pressure.
- “**Tamb**”: the measured ambient temperature.
- “**Control signal**”: the calculated fan speed reference.
- “**Local En/Dis**”: the status of the remote start/stop (dry contact between terminals Y4:1-Y4:4).
- “**BUS En/Dis**”: the status of the BMS controlled variable “**Run authorization**” (refer to screen E02).

## Screen P04

```

Pre-cooling P04
Pre-cooler A OFF
Pre-cooler B OFF
  
```

Adiabatic pre-cooling status:

- “**Pre-cooler A**”: shows the status of the adiabatic pre-cooler on side A.
- “**Pre-cooler B**”: shows the status of the adiabatic pre-cooler on side B.

## Screen P05

```

Pre-cooling P05
Program state
0: Dry op./Wait AD op.
Tpc 00000 ---
Tcww 00000 ---
Td 00000 ---
Tp 00000 ---
Deconc. counter 00
  
```

Adiabatic pre-cooling status: readout the status of the different timers and the deconcentration counter:

- “**Tpc**”: pre-cooling timer, delays the activation and deactivation of the adiabatic pre-cooling.
- “**Tcww**”: city water valve timer: extends the city water supply after the pump has started.
- “**Td**”: drain valve timer, delays emptying of the sump.
- “**Tp**”: pump timer, protects the pump against running dry.
- “**Deconc. Counter**”: counts the number of sump refills.

## Screen P10-P51

```

ecmPn_EBM_fan_HV2_P10
Offline Addr:002
Current speed 0000rpm
Max speed 00000 rpm
Power 00000W
Current 00000 mA
  
```

EC fan information screens:

- The fan status: “**Online**” or “**Offline**” and fan address: “**Addr: 002**”.
- “**Current speed**”: the actual fan speed.
- “**Max speed**”: the maximum allowable fan speed.
- “**Power**”: the actual power of the EC fan.
- “**Current**”: the actual current of the EC fan.

### Note

*In case an EC fan shows the status “Offline”, check the power supply to the fan and the Modbus communication wiring to the fan.*

## User Menu (E)



The screens in the User Menu are editable. The standard password is “1234”.

## Screen E01

```

Language E01
Language
French
Site name
BACH1607697 01
  
```

- “**Language**”: set the controller language to English, French, Dutch, Spanish or German.
- “**Site name**”: enter the unit serial number or the site name.

## Screen E02

```

Setpoints E02
Run authorisation ON
Setpoints
Standard 06.0bar
Free cooling 05.0bar
  
```

- “**Run authorization**”: activate or deactivate the unit. This variable can either be set directly in this screen or via a BMS variable (see section 6: BMS communication).
- “**Standard setpoint**”: the default setpoint for the condenser pressure.

- **“Free cooling setpoint”**: the setpoint for the condenser pressure when the unit operates in free cooling mode. Switch over to free cooling mode via a BMS controlled variable or via the dry contact between terminals Y4:2-Y4:4.

**Example**

*The controller controls the fan speed based on the actual condenser pressure and the standard setpoint when the dry contact between terminals Y4:1-Y4:4 is open.  
When the dry contact between terminals Y4:1-Y4:4 is closed, the controller controls the fan speed based on the actual condenser pressure and the free cooling setpoint.*

**Screen E03**



PI-parameters: these parameters determine the unit’s reaction speed to changes in fluid outlet temperature.

- **“Prop. Band”**: set the value for the proportional band of the PI controller.
- **“Integr. Time”**: set the value for the integration time of the PI controller.



**CAUTION**

**Changing the PI-Parameters may result in a hunting phenomenon.**

**Note**

*Make the unit react faster to changes in fluid outlet temperature by decreasing the proportional band and the integration time, or make the unit react slower by increasing the proportional band and integration time.*

**Screen E04**

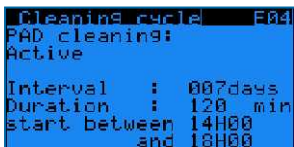

Cleaning cycle for the adiabatic pre-coolers:

- **“PAD cleaning”**: allows you to enable or disable the cleaning cycle function.
- **“Interval”**: set the period (the number of days the adiabatic pre-cooling has not functioned) after which the cleaning cycle must activate.
- **“Duration”**: set the duration for the pre-cooler cleaning cycle.
- Set the time interval for the start of the cleaning cycle.

**Example**

*The pre-cooler cleaning cycle activates the pre-coolers during 120 minutes when the unit has not operated adiabatically for a period of 7 days. The cleaning cycle starts between 14h00 and 18h00.*

**Note**

*The controller automatically disables the cleaning cycle when the ambient temperature is below 4°C.*

## Screens E05-E06

| AD switchpoints E05 |        | Pre-cooler delay E06 |       |
|---------------------|--------|----------------------|-------|
| Switchent.1         | 25.0°C | AD ON delay          | 0030s |
| Switchent.2         | 28.0°C | AD OFF delay         | 0030s |
| AD ON fan speed     | 099%   |                      |       |
| AD OFF fan speed    | 070%   |                      |       |

Adiabatic pre-cooler temperature and fan speed switchpoints and time delays:

- “**AD switchpnt.1**” and “**AD switchpnt.2**”: the temperature switchpoints for the activation of the adiabatic pre-coolers.
- “**AD ON fan speed**” and “**AD OFF fan speed**”: the fan speed switchpoints for the activation and deactivation of the adiabatic pre-coolers.
- “**AD ON delay**” and “**AD OFF delay**”: the time delays for the activation and deactivation of the adiabatic pre-coolers.

### Example

- The first pre-cooler will activate when the ambient temperature > 25.0°C **AND** the fan speed > 99%, after a 300 seconds delay.
- The second pre-cooler will activate when the ambient temperature > 28.0°C **AND** the fan speed > 99% after a 300 seconds delay.
- The first pre-cooler will deactivate when the ambient temperature < 27.9°C **OR** the fan speed < 70% after a 30 seconds delay.
- The second pre-cooler will deactivate when the ambient temperature > 24.9°C **OR** the fan speed < 70% after a 30 seconds delay.

### Note

The temperature and fan speed switchpoints determine the operating strategy of the unit. High temperature switchpoints combined with high fan speed switchpoints typically result in high water savings on the adiabatic pre-cooling, while lower temperature and fan speed switchpoints typically result in higher electrical energy savings on the EC fans.

## Screens E10-E11-E12

| Night Quiet mode E10                           | DAYTIME E11   | Night Quiet mode E12   |
|--|---|--|
| Night Quiet Mode<br>OFF                        | MON from00H00 to00H00<br>TUE from00H00 to00H00<br>WED from00H00 to00H00<br>THU from00H00 to00H00<br>FRI from00H00 to00H00<br>SAT from00H00 to00H00<br>SUN from00H00 to00H00 | AD switchpoints<br>in night quiet mode<br>Switchent.1 15.0°C<br>Switchent.2 18.0°C |
| Daytime s.limit 100.0%<br>Night s.limit 000.0% |   |  |
| Control: Clock                                 |   |  |

Night quiet mode: predefine fan speed limits for both day and night time.

- Enable/Disable the Night quiet mode and choose the maximum allowed fan speed during day and night on screen E10:
  - “**Night quiet mode**”: “**ON**” or “**OFF**”: enable or disable the Night quiet mode.
  - “**Daytime speed limit**” and “**Night time speed limit**”: set the maximum allowed fan speed during day and night time.
  - “**Control**”: choose the activation mode: either via a BMS controlled variable (“**via BMS**”) or via a predefined time daytime schedule in screen E11 (“**Clock**”).
  - “**Daytime clock**” Set up a time schedule for the daytime speed limit in screen E11: Monday to Sunday, start time to end time.



Outside of this time schedule, the night time speed limit will apply.

- “**Via BMS**”: Use parameter “**Night quiet mode day/night time speed limit via BMS**” to switch between daytime speed limit and night time speed limit (Refer to the communication tables in Chapter 6).
- Set specific adiabatic pre-cooler switchpoints for Night quiet mode operation in screen E12:
  - “**AD switchpnt.1**” and “**AD switchpnt.2**”: specific temperature switchpoints for the activation of the adiabatic pre-coolers when the night time speed limit is active.

### Example

The Night quiet mode is enabled, with a daytime speed limit of 80% and a night time speed limit of 50%.

#### During daytime:

- The first pre-cooler will activate when the ambient temperature > 25.0°C **AND** the fan speed > 79.2% (= 99% x 80%) after a 300 second delay.
- The second pre-cooler will activate when the ambient temperature > 28.0°C **AND** the fan speed > 79.2% after a 300 second delay.
- The first pre-cooler will deactivate when the ambient temperature < 27.9°C **OR** the fan speed < 56% (= 70% x 80%) after a 30 second delay.
- The second pre-cooler will deactivate when the ambient temperature > 24.9°C **OR** the fan speed < 56% after a 30 second delay.

#### During night time:

- The first pre-cooler will activate when the ambient temperature > 15.0°C **AND** the fan speed > 49.5% (= 99% x 50%) after a 300 second delay.
- The second pre-cooler will activate when the ambient temperature > 18.0°C **AND** the fan speed > 49.5% (= 70% x 80%) after a 300 second delay.
- The first pre-cooler will deactivate when the ambient temperature < 17.9 °C **OR** the fan speed < 35% (= 70% x 50%) after a 30 second delay.
- The second pre-cooler will deactivate when the ambient temperature < 14.9°C **OR** the fan speed < 35% after a 30 second delay.

### Screen E14



Adiabatic pre-cooling deactivation function:

- “**Pre-cooler deact.**”: enable or disable the pre-cooler deactivation function.
- Set the period and the time frame during which the unit deactivates the adiabatic pre-cooling.

### Example

When the pre-cooling deactivation function is active, the adiabatic pre-cooling cannot activate between 13:00 and 15:00 o'clock from 15/07 to 15/09.

### Screen E15

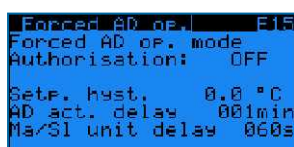

The forced adiabatic operation function allows the unit to activate both pre-coolers simultaneously when the ambient temperature exceeds the fluid outlet setpoint.

### Screen E16

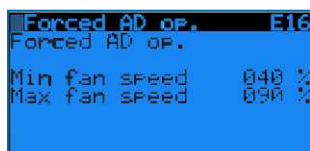

- “**Forced AD op. mode authorization**”: enable or disable the forced adiabatic operation function.
- “**Setp. hyst.**”: hysteresis on the fluid outlet temperature setpoint.
- “**AD act. Delay**”: time delay for the activation of the forced adiabatic operation mode.
- “**Ma/SI unit delay**”: time delay for the activation and deactivation of the pre-cooling in forced adiabatic operation mode.

- **“Min fan speed”**: fan speed switchpoint for deactivation of the pre-cooling in the forced adiabatic operation mode.
- **“Max fan speed”**: fan speed switchpoint for activation of the pre-cooling in the forced adiabatic operation mode.

**Example**

The forced adiabatic mode activates when  $T_{amb} > (\text{“setpoint”} + \text{“setp. hyst.”}) > (30^{\circ}\text{C} + 0^{\circ}\text{C}) > 30^{\circ}\text{C}$  during 1 minute.

While in forced adiabatic mode, the pre-cooling activates and deactivates as follows:

- When the fans operate between 90% (**“Max fan speed”**) and 99%, the pre-cooling activates after 60 s (**“Ma/SI unit delay”**).
- When the fans operate at full speed (100%), the pre-cooling activates after 5 s.
- When the fans operate between 30% and 40% (**“Min fan speed”**), the pre-cooling deactivates after 60 s (**“Ma/SI unit delay”**).
- When the fans stop running, the pre-cooling deactivates immediately.

**Screen E17**



Choose the communication protocol: Modbus RS485, Modbus IP, Carel RS485, LON, BacNet IP or BacNet MSTP. Set the communication speed and network address, when applicable. See section 6: BMS communication.

**Screen E18**

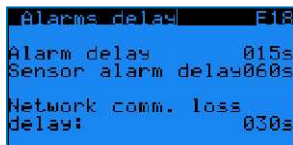

Alarm detection delays:

- **“Alarm delay”**: time delay for EC fan alarms and warnings.
- **“Sensor alarm delay”**: time delay for alarms from the fluid outlet temperature and ambient temperature sensor.
- **“Network comm. Loss delay”**: time delay for the loss of pLAN communication between units (not applicable for stand-alone operation).

**Note**

The network communication loss delay is not applicable to stand alone operation.

**Screens E19-E20**

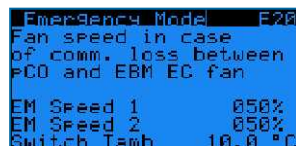
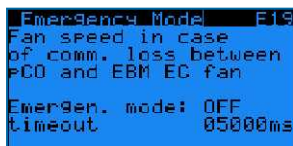

EC fan emergency mode management:

Enable the EC fan emergency mode to select a fixed fan speed for when the Modbus communication between the controller and the EC fans fails.

In case the EC fan emergency mode is disabled, the fans will continue to operate at the latest known fan speed when the Modbus communication between the controller and the EC fans fails.

- **“Emergen. mode”**: “ON” or “OFF”: enable or disable the EC fan emergency mode.
- **“Timeout”**: time delay before the EC fan emergency mode activates.
- **“EM speed 1”**: the emergency speed reference in case the ambient temperature  $\geq$  the ambient temperature switchpoint.

- “**EM speed 2**”: the emergency speed reference in case the ambient temperature < the ambient temperature switchpoint.
- “**Switch Tamb**”: the ambient temperature switchpoint.

**Example** | When the EC fan emergency mode is enabled, EM speed 1 is set to 100%, EM speed 2 is set to 50% and Switch Tamb is set to 15°C, the EC fans will start running at a fixed speed of 100% in case the Modbus communication between the controller and the EC fans fails when the ambient temperature is 20°C.  
 In case, the Modbus communication between the controller and the EC fans fails when the ambient temperature is 10°C, the EC fans will start running at a fixed speed of 50%.

### Screen E21

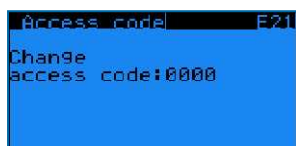

Set your own access code for the User Menu.

## Working Time Menu (T)



The screens in the Working Time Menu are read only and cannot be edited.

### Screen T02



Read the operating time for the EC fans and for both adiabatic pre-coolers, displayed in hours.

### Screen T03

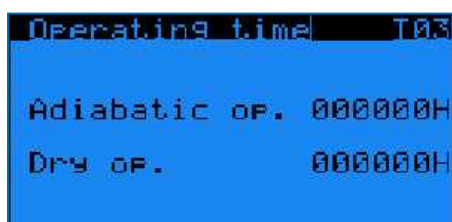

Read the operating time for the EC fans, both adiabatic pre-coolers, and the dry and adiabatic operating time displayed in hours.

# Inputs Outputs Menu (I)



The screens in the Inputs/Outputs Menu are read only and cannot be edited.

## Screens I01-I02



Read the analog inputs on the controller:

- “**U1: Tout**”: the current condenser pressure.
- “**U2: T°C Tgen**”: not used.
- “**U3: T°C Tamb**”: the current ambient temperature.

## Screen I03



Read the status of the digital inputs on the controller (open/closed):

- “**ID4-DI: Inverter AI**”: VFD status (not used in case of unit working with EC fans).
- “**ID5-DI: Free cooling**”: status of the free cooling mode (dry contact between terminals Y4:2-Y4:4).
- “**ID1: On-Off**”: status of the remote start/stop command (dry contact between terminals Y4:1-Y4:4).
- “**U5: Fan AI**”: not used.

## Screen I04

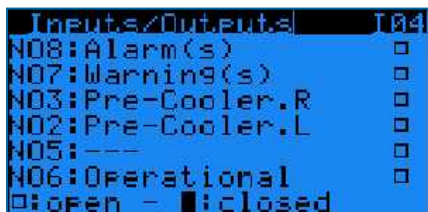

Read the status of the digital outputs on the controller (open/closed).

- “**NO8: Alarm(s)**”: closed contact means that there are one or more alarms active.
- “**NO7: Warning(s)**”: a closed contact means that there are one or more warnings active.
- “**NO3: RH Pre-cooler**”: a closed contact means that the right pre-cooler is active.
- “**NO2: LH Pre-cooler**”: a closed contact means that the left pre-cooler is active.
- “**NO5: ---**”: not used.
- “**NO6: Operational**”: run indication, a closed contact means that the fans are running.



## Screen I05



Read the analog outputs on the controller:

- “**Y3: N.U**”: not used.
- “**Y4: Fan speed**”: a 0-10 Volt control signal, which corresponds to the actual fan speed. (0 V = 0%, 10 V = 100%)

## Clock Menu (K)



The screen in the Clock Menu is editable.

### Screen K01



Set the correct time and date. Time format: HH:MM:SS and date format: DD/MM/YY.

The software automatically adjusts to Daylight Saving Time.

## Logger Menu (H)



The screens in the Logger Menu are read only and cannot be edited.

### Screen H01



Read the history of past alarms.

The log shows the alarm message and the time the alarm occurred.

# System Information (S)



The screens in System Information are read only and cannot be edited.

## Screen S01

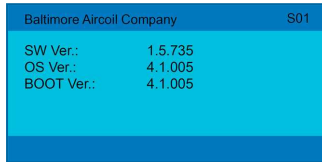

"SW Ver.": Current software version installed

"OS Ver.": Operating system version

"BOOT Ver.": Current boot version

# Maintenance Menu (M)

## Screen M01



Program a sensor offset ("Corr. :") to correct the readings for the condenser pressure sensor ("Outlet (U1)") and the ambient temperature sensor ("Tamb (U3)").

The general outlet pressure sensor is not used in stand-alone operation.

## Screen M02

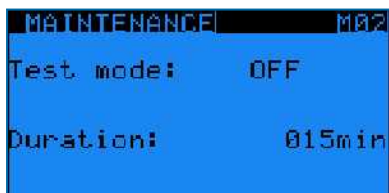

Activate the test mode, which allows to manually set analog and digital outputs and control the EC fans.

- "Test mode": activate or deactivate the test mode.
- "Duration": time delay after which the test mode automatically deactivates.

### Note

1. Duration set to 99 min keeps the test mode ON indefinitely
2. When the test mode is set to OFF, screens M03 to M07 are invisible.

### Screen M03

```

Dig. out. override M03
Pre-cooler R (N03): 
Pre-cooler L (N02): 
Run indicat. (N06): 
Alarm (N08): 
Warning (N07): 
: Open / : Closed
  
```

Manually set the digital outputs:

- “**Pre-cooler R**”: activate or deactivate the right hand pre-cooler.
- “**Pre-cooler L**”: activate or deactivate the left hand pre-cooler.
- “**Run indicat.**”: simulate the run indication.
- “**Alarm**”: simulate an alarm.
- “**Warning**”: simulate a warning.

### Screen M05

```

Test. mode: M05
Output override
analog:
Y3:000.0 Volt
Y4:000.0 Volt
  
```

Manually set the analog outputs:

- “**Y3**”: not used for a unit with EC fan motors.
- “**Y4**”: simulate a 0-10 Volt output.

### Screen M06

```

Global fan test M06
Fan speed 000.0%
Control type Global
  
```

Manually control the EC fans:

- “**Fan speed**”: 0% to 100%
- “**Control type**”: choose “**Global**” to operate all fans simultaneously at the same speed or choose “**1 by 1**” to set the speed for each fan individually via screen M07.

### Screen M07

```

Test indiv. fans M07
N° 2 000.0% N° 9 000.0%
N° 3 000.0% N° 10 000.0%
N° 4 000.0% N° 11 000.0%
N° 5 000.0% N° 12 000.0%
N° 6 000.0% N° 13 000.0%
N° 7 000.0% N° 14 000.0%
N° 8 000.0% N° 15 000.0%
  
```

Set the speed for each fan individually.

## Alarms overview

- Access the alarms by pressing the alarm button on the controller (triangle with exclamation mark).
- If a particular alarm is no longer present, the alarm message is automatically cleared and the general alarm (NO1) deactivates.
- To see the history of past alarms, check the logger menu.

**Note**

*The Alarm status can be read out via dry contact on terminal Y3: 3/4/5 and the warning status on Y3: 1/2 in the control panel.*

### Screen AL000

No alarm present.

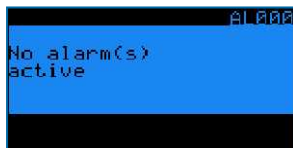

### Screen AL001



Condenser pressure sensor (on input U1) is defective.

- Unit stops working.
- Alarm message AL001 on controller display + general alarm (NO1) activates.

### Screen AL003



Ambient air temperature sensor (on input U3) is defective.

- Unit remains operational in dry mode, adiabatic operation no longer possible.
- Alarm message AL003 on controller display + general alarm (NO1) activates.

## Screens AL010-AL106



Alarms and warnings from the EC fans. Consult BAC factory for more information.

- Unit remains operational, but the defective fan stops working.





## BMS COMMUNICATION





### Available communication protocols and communication cards

The following communication protocols are available: Carel RS485, Modbus RS485, Modbus TCP/IP, Bacnet IP, Bacnet MS/TP and LON. The table below shows the required communication card and software settings for each communication protocol.



Based on your selection, this manual will only contain the information you require.

| Protocol      | Communication card reference  | Typical parameter settings in the controller   | Interface file required? | Available settings  |
|---------------|---|--|--------------------------|---|
| CAREL RS485   |  | <pre>Supervision E17 BMS communication CAREL RS485 Baud rate 19200 Address 001</pre>                         | No                       | - Baudrate: 1200 to 19200<br>- Slave addresses: 1 to 207  |
| Modbus RS485  |  | <pre>Supervision E17 BMS communication Modbus RS485 Baud rate 19200 Address 001 Parity None Stop Bit 2</pre> | No                       | - Baudrate: 1200 to 19200<br>- Parity: None, Even or Odd<br>- Nbr. stop bits: 1 or 2<br>- Slave addresses: 1 to 207 |
| Modbus TCP/IP |  | <pre>Supervision E17 BMS communication Modbus IP</pre>   | No                       |   |
| Bacnet IP     |  | <pre>Supervision E17 BMS communication Bacnet IP</pre>   | No                       |   |

| Protocol     | Communication card reference  | Typical parameter settings in the controller                                      | Interface file required? | Available settings |
|--------------|---|---|--------------------------|--------------------|
| Bacnet MS/TP |  |  | No                       |                    |
| LON          |  |  | Yes (Xif and Nxe file)   |                    |

## Communication table for Modbus RS485

| Variable                                 | UOM | R/W | Modbus |         |          |
|--|-----|-----|--------|---------|----------|
|  |     |     | Index  | Address | Type     |
| Condenser pressure                       | Bar | R   | 1      | 2       | register |
| Ambient temperature                      | °C  | R   | 3      | 4       | register |
| AD switchpoint 1                         | °C  | R/W | 4      | 5       | register |
| AD switchpoint 2                         | °C  | R/W | 5      | 6       | register |
| Night quiet mode: AD switchpoint 1       | °C  | R/W | 8      | 9       | register |
| Night quiet mode: AD switchpoint 2       | °C  | R/W | 9      | 10      | register |
| Active setpoint                          | Bar | R   | 10     | 11      | register |
| Regular setpoint                         | Bar | R/W | 11     | 12      | register |
| Free cooling setpoint                    | Bar | R/W | 12     | 13      | register |
| Proportional band                        | °C  | R/W | 15     | 16      | register |
| Night quiet mode: daytime speed limit    | %   | R/W | 16     | 17      | register |
| Night quiet mode: night time speed limit | %   | R/W | 17     | 18      | register |
| Daytime clock: Monday start hours        | h   | R/W | 5007   | 5008    | register |
| Daytime clock: Monday start minutes      | m   | R/W | 5008   | 5009    | register |
| Daytime clock: Monday end hours          | h   | R/W | 5009   | 5010    | register |
| Daytime clock: Monday end minutes        | m   | R/W | 5010   | 5011    | register |
| Daytime clock: Tuesday start hours       | h   | R/W | 5011   | 5012    | register |
| Daytime clock: Tuesday start minutes     | m   | R/W | 5012   | 5013    | register |
| Daytime clock: Tuesday end hours         | h   | R/W | 5013   | 5014    | register |
| Daytime clock: Tuesday end minutes       | m   | R/W | 5014   | 5015    | register |
| Daytime clock: Wednesday start hours     | h   | R/W | 5015   | 5016    | register |
| Daytime clock: Wednesday start minutes   | m   | R/W | 5016   | 5017    | register |
| Daytime clock: Wednesday end hours       | h   | R/W | 5017   | 5018    | register |
| Daytime clock: Wednesday end minutes     | m   | R/W | 5018   | 5019    | register |
| Daytime clock: Thursday start hours      | h   | R/W | 5019   | 5020    | register |
| Daytime clock: Thursday start minutes    | m   | R/W | 5020   | 5021    | register |
| Daytime clock: Thursday end hours        | h   | R/W | 5021   | 5022    | register |
| Daytime clock: Thursday end minutes      | m   | R/W | 5022   | 5023    | register |
| Daytime clock: Friday start hours        | h   | R/W | 5023   | 5024    | register |
| Daytime clock: Friday start minutes      | m   | R/W | 5024   | 5025    | register |
| Daytime clock: Friday end hours          | h   | R/W | 5025   | 5026    | register |
| Daytime clock: Friday end minutes        | m   | R/W | 5026   | 5027    | register |
| Daytime clock: Saturday start hours      | h   | R/W | 5027   | 5028    | register |
| Daytime clock: Saturday start minutes    | m   | R/W | 5028   | 5029    | register |



| Variable   | UOM  | R/W | Modbus |         |          |
|--|------|-----|--------|---------|----------|
|  |      |     | Index  | Address | Type     |
| Daytime clock: Saturday end hours                      | h    | R/W | 5029   | 5030    | register |
| Daytime clock: Saturday end minutes                    | m    | R/W | 5030   | 5031    | register |
| Daytime clock: Sunday start hours                      | h    | R/W | 5031   | 5032    | register |
| Daytime clock: Sunday start minutes                    | m    | R/W | 5032   | 5033    | register |
| Daytime clock: Sunday end hours                        | h    | R/W | 5033   | 5034    | register |
| Daytime clock: Sunday end minutes                      | m    | R/W | 5034   | 5035    | register |
| Night quiet mode: Control type (0: clock - 1: via BMS) | ---  | R/W | 5035   | 5036    | register |
| Integration time                                       | sec  | R/W | 5037   | 5038    | register |
| Cleaning cycle: interval                               | days | R/W | 5038   | 5039    | register |
| Cleaning cycle: duration                               | min  | R/W | 5039   | 5040    | register |
| AD ON fan speed  | %    | R/W | 5040   | 5041    | register |
| AD OFF fan speed                                       | %    | R/W | 5041   | 5042    | register |
| AD ON delay  | sec  | R/W | 5042   | 5043    | register |
| AD OFF delay   | sec  | R/W | 5043   | 5044    | register |
| Unit pLAN address                                      | ---  | R   | 5051   | 5052    | register |
| Pre-cooling Deactivation function: start day           | ---  | R/W | 5056   | 5057    | register |
| Pre-cooling Deactivation function: start month         | ---  | R/W | 5057   | 5058    | register |
| Pre-cooling Deactivation function: end day             | ---  | R/W | 5058   | 5059    | register |
| Pre-cooling Deactivation function: end month           | ---  | R/W | 5059   | 5060    | register |
| Pre-cooling Deactivation function: start hour          | h    | R/W | 5060   | 5061    | register |
| Pre-cooling Deactivation function: end hour            | h    | R/W | 5062   | 5063    | register |
| Alarm delay  | sec  | R/W | 5068   | 5069    | register |
| Sensor alarm delay                                     | sec  | R/W | 5069   | 5070    | register |
| Fan speed  | %    | R   | 5077   | 5078    | register |
| EC fan N°2: actual speed                               | rpm  | R   | 5078   | 5079    | register |
| EC fan N°2: maximum allowable speed                    | rpm  | R   | 5079   | 5080    | register |
| EC fan N°2: actual power                               | W    | R   | 5080   | 5081    | register |
| EC fan N°3: actual speed                               | rpm  | R   | 5082   | 5083    | register |
| EC fan N°3: maximum allowable speed                    | rpm  | R   | 5083   | 5084    | register |
| EC fan N°3: actual power                               | W    | R   | 5084   | 5085    | register |
| EC fan N°4: actual speed                               | rpm  | R   | 5086   | 5087    | register |
| EC fan N°4: maximum allowable speed                    | rpm  | R   | 5087   | 5088    | register |
| EC fan N°4: actual power                               | W    | R   | 5088   | 5089    | register |
| EC fan N°5: actual speed                               | rpm  | R   | 5090   | 5091    | register |
| EC fan N°5: maximum allowable speed                    | rpm  | R   | 5091   | 5092    | register |
| EC fan N°5: actual power                               | W    | R   | 5092   | 5093    | register |
| EC fan N°6: actual speed                               | rpm  | R   | 5094   | 5095    | register |
| EC fan N°6: maximum allowable speed                    | rpm  | R   | 5095   | 5096    | register |
| EC fan N°6: actual power                               | W    | R   | 5096   | 5097    | register |
| EC fan N°7: actual speed                               | rpm  | R   | 5098   | 5099    | register |
| EC fan N°7: maximum allowable speed                    | rpm  | R   | 5099   | 5100    | register |
| EC fan N°7: actual power                               | W    | R   | 5100   | 5101    | register |
| EC fan N°8: actual speed                               | rpm  | R   | 5102   | 5105    | register |
| EC fan N°8: maximum allowable speed                    | rpm  | R   | 5103   | 5103    | register |
| EC fan N°8: actual power                               | W    | R   | 5104   | 5104    | register |
| EC fan N°9: actual speed                               | rpm  | R   | 5106   | 5107    | register |
| EC fan N°9: maximum allowable speed                    | rpm  | R   | 5107   | 5108    | register |
| EC fan N°9: actual power                               | W    | R   | 5108   | 5109    | register |
| EC fan N°10: actual speed                              | rpm  | R   | 5110   | 5111    | register |
| EC fan N°10: maximum allowable speed                   | rpm  | R   | 5111   | 5112    | register |
| EC fan N°10: actual power                              | W    | R   | 5112   | 5113    | register |
| EC fan N°11: actual speed                              | rpm  | R   | 5114   | 5115    | register |
| EC fan N°11: maximum allowable speed                   | rpm  | R   | 5115   | 5116    | register |



| Variable   | UOM | R/W | Modbus |         |          |
|--|-----|-----|--------|---------|----------|
|  |     |     | Index  | Address | Type     |
| EC fan N°11: actual power  | W   | R   | 5116   | 5117    | register |
| EC fan N°12: actual speed  | rpm | R   | 5118   | 5119    | register |
| EC fan N°12: maximum allowable speed                                 | rpm | R   | 5119   | 5120    | register |
| EC fan N°12: actual power  | W   | R   | 5120   | 5121    | register |
| EC fan N°13: actual speed  | rpm | R   | 5122   | 5123    | register |
| EC fan N°13: maximum allowable speed                                 | rpm | R   | 5123   | 5124    | register |
| EC fan N°13: actual power  | W   | R   | 5124   | 5125    | register |
| EC fan N°14: actual speed  | rpm | R   | 5126   | 5127    | register |
| EC fan N°14: maximum allowable speed                                 | rpm | R   | 5127   | 5128    | register |
| EC fan N°14: actual power  | W   | R   | 5128   | 5129    | register |
| EC fan N°15: actual speed  | rpm | R   | 5130   | 5131    | register |
| EC fan N°15: maximum allowable speed                                 | rpm | R   | 5131   | 5132    | register |
| EC fan N°15: actual power  | W   | R   | 5132   | 5133    | register |
| Standard/Free cooling switch over<br>(0: Standard / 1: Free cooling) | --- | R/W | 1      | 2       | coil     |
| Free cooling status (0: OFF / 1: ON)                                 | --- | R   | 2      | 3       | coil     |
| Night quiet mode (0: disable / 1: enable)                            | --- | R/W | 4      | 5       | coil     |
| Night quiet mode status (0: not active / 1: active)                  | --- | R   | 5      | 6       | coil     |
| Night quiet mode: clock mode active<br>(0: NO / 1: YES)              | --- | R   | 6      | 7       | coil     |
| Night quiet mode: BMS mode active<br>(0: NO / 1: YES)                | --- | R   | 7      | 8       | coil     |
| Night quiet modeday/night time speedlimit via BMS (0:night / 1:day)  | --- | R/W | 8      | 9       | coil     |
| Run authorization (0: OFF / 1: ON)                                   | --- | R/W | 9      | 10      | coil     |
| Cleaning cycle (0: disable / 1: enable)                              | --- | R/W | 10     | 11      | coil     |
| Pre-cooling deactivation function (0: disable / 1: enable)           | --- | R/W | 11     | 12      | coil     |
| NO1 relay output status: Alarm(s) (0:No alarm / 1:Alarm)             | --- | R   | 13     | 14      | coil     |
| NO2 relay output status: Warning(s) (0:No warning / 1:Warning)       | --- | R   | 14     | 15      | coil     |
| NO3 relay output status: RH Pre-cooler (0:open / 1:closed)           | --- | R   | 15     | 16      | coil     |
| NO4 relay output status: LH Pre-cooler (0:open / 1:closed)           | --- | R   | 16     | 17      | coil     |
| NO6 relay output status: Run indication (0:stopped / 1:running)      | --- | R   | 18     | 19      | coil     |
| B6 Dig In status - Free cooling mode (0: Disabled / 1:Enabled)       | --- | R   | 21     | 22      | coil     |
| ID1 - Remote start/stop status (0: off / 1: on)                      | --- | R   | 22     | 23      | coil     |
| Alarm sensor B1 (fluid outlet temperature sensor)                    | --- | R   | 24     | 25      | coil     |
| EBM N°2 - alarm/warning present                                      | --- | R   | 29     | 30      | coil     |
| EBM N°3 - alarm/warning present                                      | --- | R   | 30     | 31      | coil     |
| EBM N°4 - alarm/warning present                                      | --- | R   | 31     | 32      | coil     |
| EBM N°5 - alarm/warning present                                      | --- | R   | 32     | 33      | coil     |
| EBM N°6 - alarm/warning present                                      | --- | R   | 33     | 34      | coil     |
| EBM N°7 - alarm/warning present                                      | --- | R   | 34     | 35      | coil     |
| EBM N°8 - alarm/warning present                                      | --- | R   | 35     | 36      | coil     |
| EBM N°9 - alarm/warning present                                      | --- | R   | 36     | 37      | coil     |
| EBM N°10 - alarm/warning present                                     | --- | R   | 37     | 38      | coil     |
| EBM N°11 - alarm/warning present                                     | --- | R   | 38     | 39      | coil     |
| EBM N°12 - alarm/warning present                                     | --- | R   | 39     | 40      | coil     |
| EBM N°13 - alarm/warning present                                     | --- | R   | 40     | 41      | coil     |
| EBM N°14 - alarm/warning present                                     | --- | R   | 41     | 42      | coil     |
| EBM N°15 - alarm/warning present                                     | --- | R   | 42     | 43      | coil     |
| Alarm present  | --- | R   | 59     | 60      | coil     |
| Unit status (0: OFF / 1: ON)   | --- | R   | 63     | 64      | coil     |
| Warning present  | --- | R   | 66     | 67      | coil     |
| Alarm sensor B4 (ambient temperature sensor)                         | --- | R   | 67     | 68      | coil     |

# FURTHER ASSISTANCE & INFORMATION

## More information

### REFERENCE LITERATURE

- Eurovent 9-5 (6) Recommended Code of Practice to keep your Cooling System efficient and safe. Eurovent/Cecomaf, 2002, 30p.
- Guide des Bonnes Pratiques, Legionella et Tours Aéroréfrigérantes. Ministères de l'Emploi et de la Solidarité, Ministère de l'Economie des Finances et de l'Industrie, Ministère de l'Environnement, Juin 2001, 54p.
- Voorkom Legionellose. Ministerie van de Vlaamse Gemeenschap. December 2002, 77p.
- Legionnaires' Disease. The Control of Legionella Bacteria in Water Systems. Health & Safety Commission. 2000, 62p.
- Hygienische Anforderungen an raumlufttechnische Anlagen. VDI 6022.

### INTERESTING WEBSITES

|   |  |
|---|--|
| Baltimore Aircoil Company   | <a href="http://www.BaltimoreAircoil.com">www.BaltimoreAircoil.com</a>             |
| BAC Service website   | <a href="http://www.BACservice.eu">www.BACservice.eu</a>                           |
| Eurovent  | <a href="http://www.eurovent-certification.com">www.eurovent-certification.com</a> |
| European Working Group on Legionella Infections (EWGLI)                       | <a href="http://EWGLI">EWGLI</a>   |
| ASHRAE  | <a href="http://www.ashrae.org">www.ashrae.org</a>                                 |
| Uniclimate  | <a href="http://www.uniclimate.fr">www.uniclimate.fr</a>                           |
| Association des Ingénieurs et techniciens en Climatique, Ventilation et Froid | <a href="http://www.aicvf.org">www.aicvf.org</a>                                   |
| Health and Safety Executive   | <a href="http://www.hse.gov.uk">www.hse.gov.uk</a>                                 |

### ORIGINAL DOCUMENTATION



This manual is originally made in English. Translations are provided for your convenience. In the event of discrepancies, the English original text shall prevail over the translation.

## The service expert for BAC equipment

We offer tailored services and solution for BAC cooling towers and equipment.

- Original spare parts and fill -for an efficient, safe and year round reliable operation.
- Service solutions - preventive maintenance, repairs, refurbishments, cleaning and disinfection for reliable trouble-free operation.
- Upgrades and new technologies - save up energy and improve maintenance by upgrading your system.
- Water treatment solutions - equipment for controlling corrosion scaling and proliferation of bacteria.

For more details, contact your local BAC representative for further information and specific assistance at [www.BACservice.eu](http://www.BACservice.eu)



A series of horizontal dotted lines for writing, spanning the width of the page.



A series of horizontal dotted lines spanning the width of the page, providing a template for writing or data entry.





A series of horizontal dotted lines for writing, spanning the width of the page.



A series of horizontal dotted lines for writing, spanning the width of the page.





A series of horizontal dotted lines for writing, spanning the width of the page.



A series of horizontal dotted lines spanning the width of the page, providing a template for writing or drawing.





COOLING TOWERS

---

CLOSED CIRCUIT COOLING TOWERS

---

ICE THERMAL STORAGE

---

EVAPORATIVE CONDENSERS

---

HYBRID PRODUCTS

---

PARTS, EQUIPMENTS & SERVICES

BLUE by nature  
GREEN at heart



[www.BaltimoreAircoil.com](http://www.BaltimoreAircoil.com)

[Europe@BaltimoreAircoil.com](mailto:Europe@BaltimoreAircoil.com)

Please refer to our website for local contact details.

Industriepark - Zone A, B-2220 Heist-op-den-Berg, Belgium

© Baltimore Aircoil International nv